



www.carolinastair.com



CAROLINA

STAIR SUPPLY

EDITION 14

**Wood
& Iron**

Search
Houzz.com
for Carolina
Stair

316 Herrick Street, Uhrichsville, Ohio 44683

Tel: 800-364-3269

Tel: 740-922-3333

Fax: 740-922-3330



Table of Contents

- Special Order Species 2
- Contemporary Series..... 5
- Buckeye Series 6
- Hampton Series 7
- Carolina Series 8-9
- Square Savannah Series 10
- Savannah Series 11
- Biltmore Series 12
- Traditional Series..... 13
- Victorian Newels 14
- Victorian Accessories 15
- Rail Profiles 16-17
- Fittings - Quarterturns, Goosenecks 18
- Fittings - Easements, Caps, Turnouts, Volutes 19
- Linear 20
- Treads, Riser, Linear Items..... 21
- Custom Turnings 22-31
- Iron Finish Options 32
- Powder Coated Regular Twist & Scroll..... 33
- Tapered & Hammered Balusters 34
- Ribbon Twist 35
- Forged Gothic 36
- Hand Forged Balusters 37
- Wave & Curl Forged Balusters 38
- Knee Wall Balusters 39
- Square Stamped & Modern 40
- Iron Accessories & Rail Zip Clip 41
- Fusion & Horizontal Bar 43
- Olé Iron Slides™ Indoor & Outdoor 44-45
- Accessories 46



316 Herrick Street, Uhrichsville, Ohio 44683

Tel: 800-364-3269
 Tel: 740-922-3333
 Fax: 740-922-3330

The 3X Concept

Developed to increase ordering efficiency, the 3X Concept ensures a perfect fit by simply trimming off the excess length from the top of the baluster. It can be applied to the following:

Page 9: #4415-P
 #4415-F
 #4415-T

Page 11: #5011-P Page 12: #5715-P
 #4011-P #5715-F
 #4011-F #5715-R



We also offer a priming service for all of our products. Available in flat or gloss white finish.

Pictured:
 Left: 5015
 Right: 4003-F

All newels and balusters featured in this catalog are available in Oak or Poplar.

In addition to our Oak and Poplar parts that we stock, we are pleased to offer all of the products in this catalog, by special order, in the following species:



Carolina Stair featured in Southern Living Magazine's Texas makeover Idea House.



"Courtesy Time Inc., including its Southern Living division, photograph by Hector Manuel Sanchez. SOUTHERN LIVING is a registered trademark of Time Inc. and is used with permission."

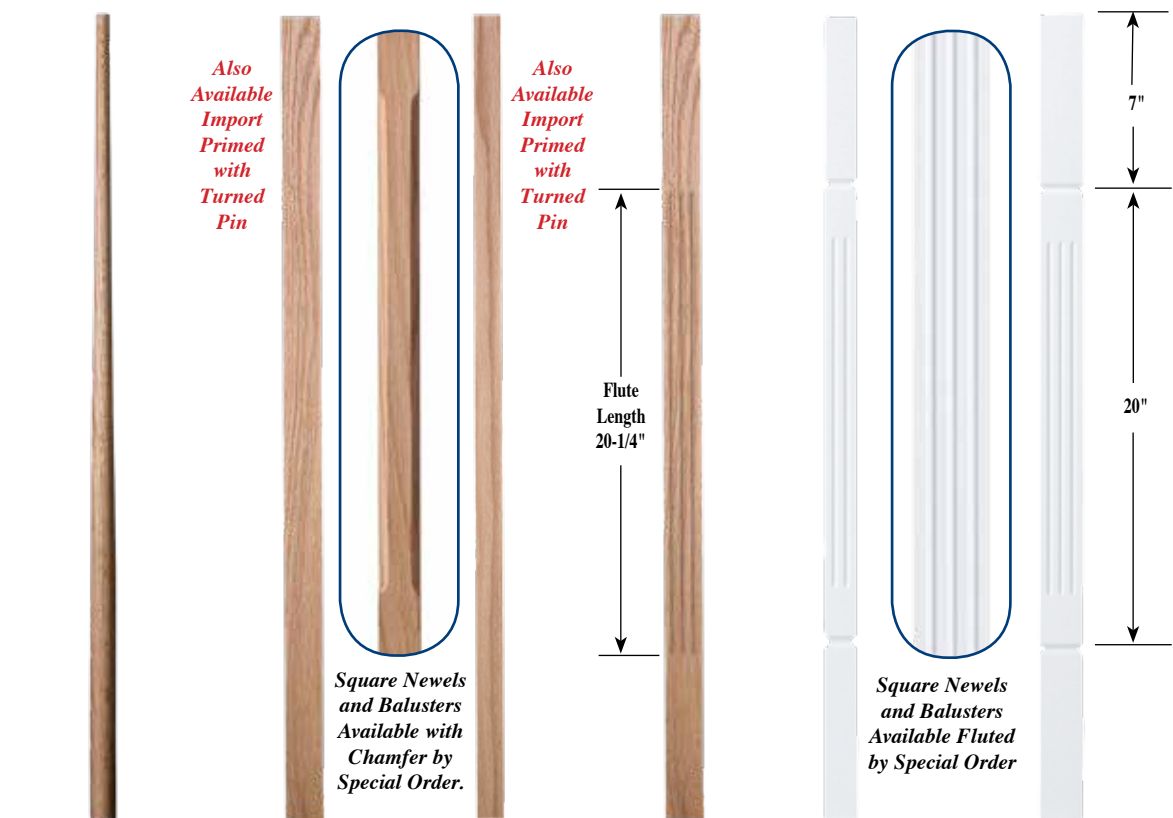

0150-P Round Pool Cue	0175-P 1-3/4" x 31" 1-3/4" x 34" 1-3/16" x 39" 1-3/16" x 41" Includes Dowel	0125-P 1-1/4" x 31" 1-1/4" x 34" 1-1/4" x 36" 1-1/4" x 39" 1-1/4" x 42"	0175-F 1-3/4" x 31" 1-3/4" x 34" 1-3/4" x 36" 1-3/4" x 39" 1-3/4" x 42"	0125-VFL 1-1/4" x 31" 1-1/4" x 34" 1-1/4" x 36" 1-1/4" x 39" 1-1/4" x 42"	0175-VFL 1-3/4" x 31" 1-3/4" x 34" 1-3/4" x 36" 1-3/4" x 39" 1-3/4" x 42"
---------------------------------	---	---	---	---	---

800-364-3269

Available in most species

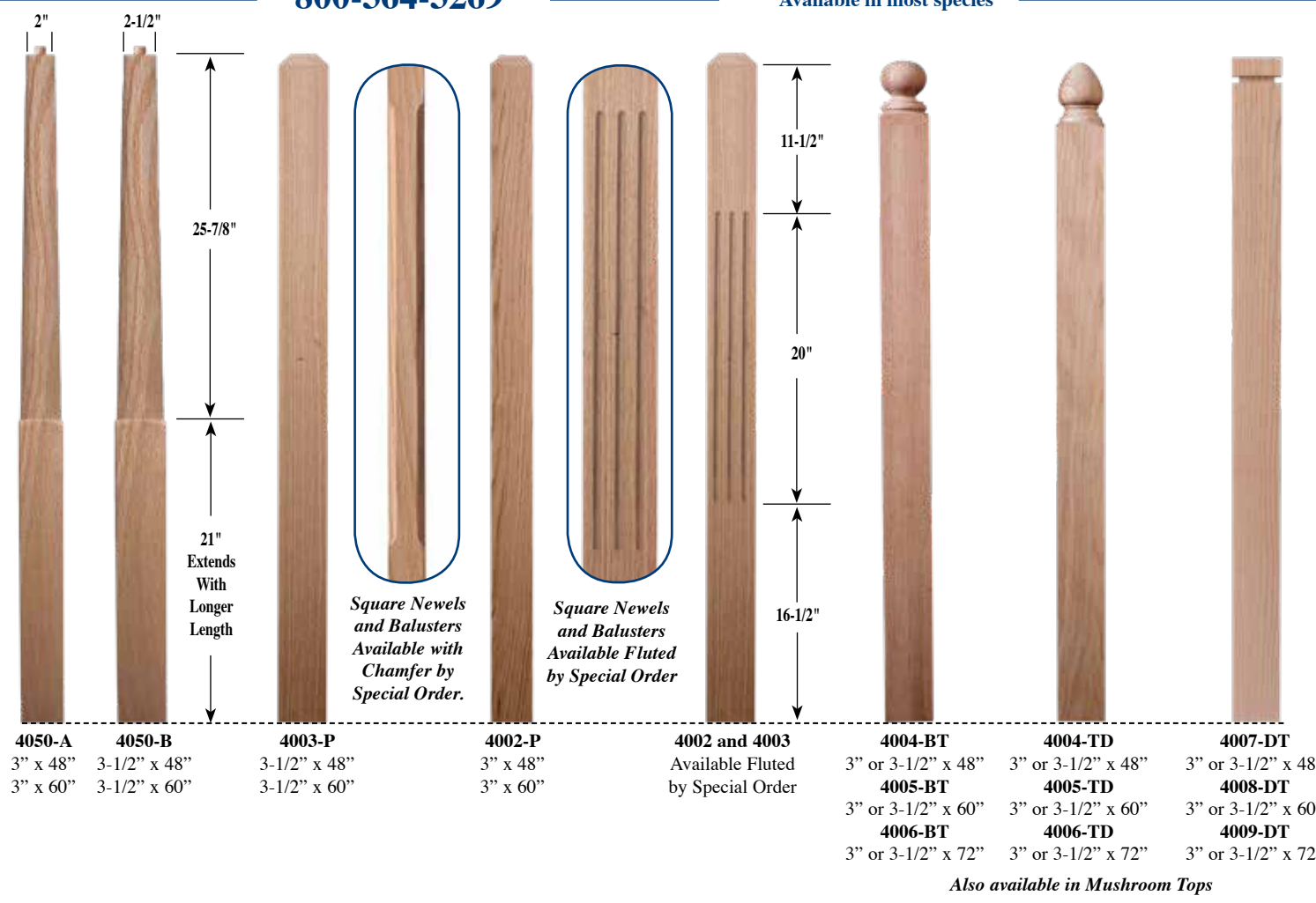

Contemporary

Newels

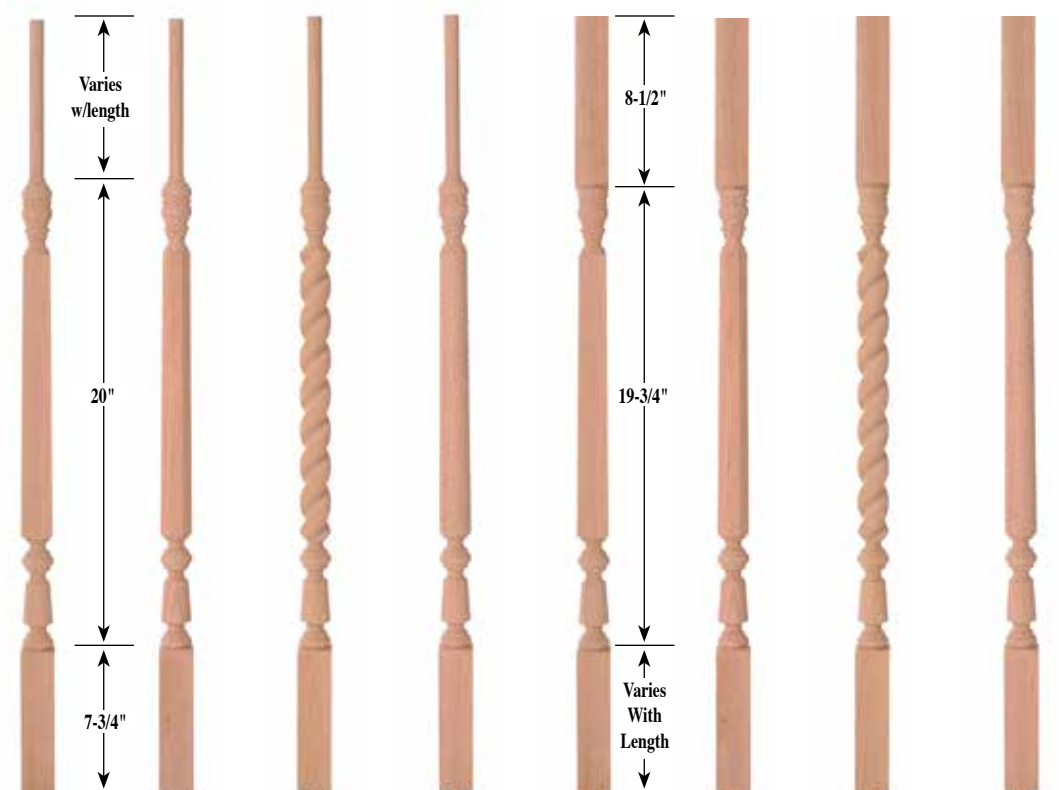

2415-TAP 1-3/4" x 36" 1-3/4" x 39" 1 3/4" x 41"	2415-OCT 1-3/4" x 36" 1-3/4" x 39" 1 3/4" x 41"	2415-TW 1-3/4" x 36" 1-3/4" x 39" 1 3/4" x 41"	2415-OT 1-3/4" x 36" 1-3/4" x 39" 1 3/4" x 41"	2405-TAP 1-3/4" x 36" 1-3/4" x 39" 1 3/4" x 41"	2405-OCT 1-3/4" x 39" 1 3/4" x 41"	2405-TW 1-3/4" x 36" 1-3/4" x 39" 1 3/4" x 41"	2405-OT 1-3/4" x 36" 1-3/4" x 39" 1 3/4" x 41"
---	---	--	--	---	---	--	--

By Special Order

800-364-3269

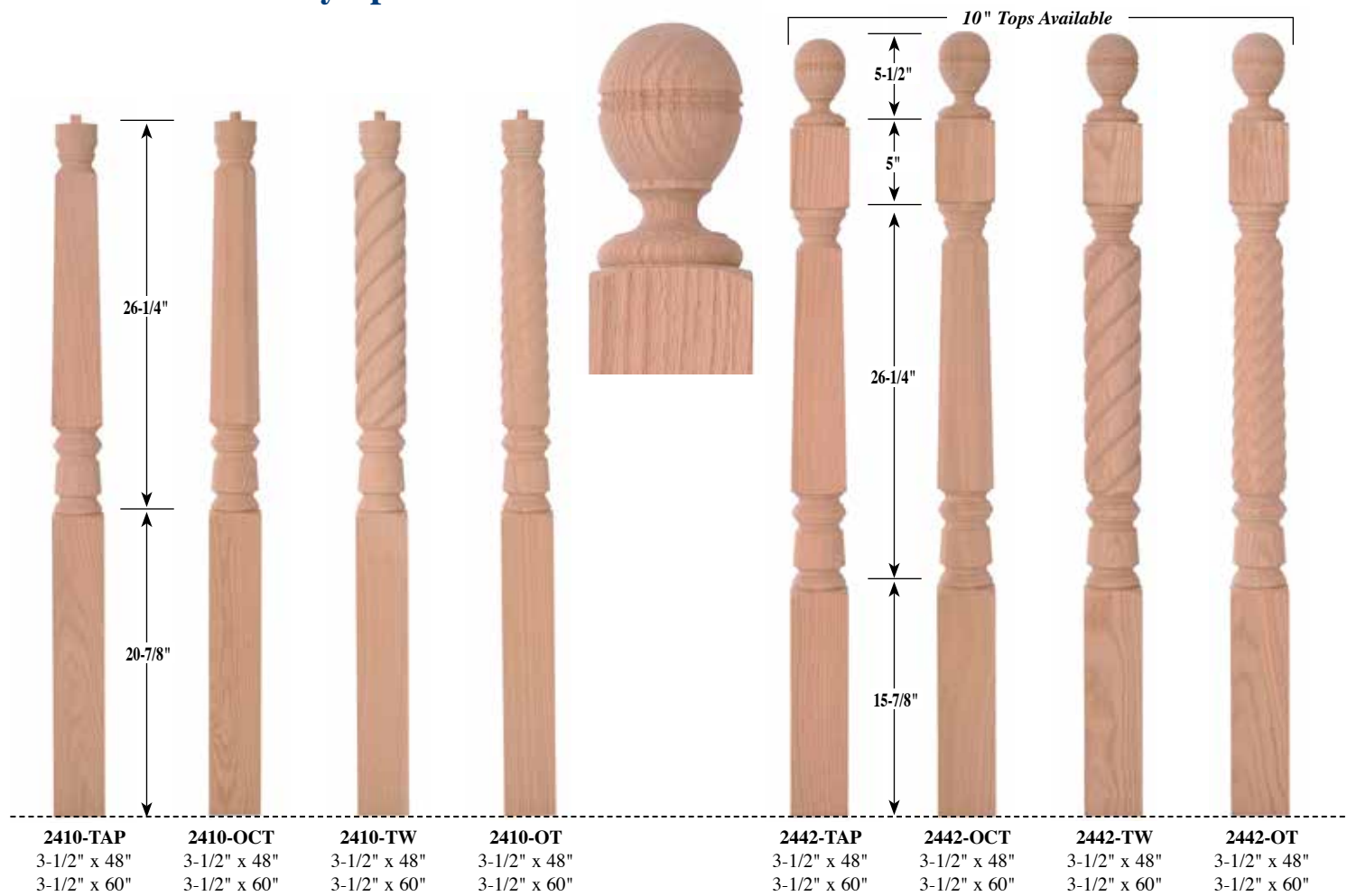

2410-TAP 3-1/2" x 48" 3-1/2" x 60"	2410-OCT 3-1/2" x 48" 3-1/2" x 60"	2410-TW 3-1/2" x 48" 3-1/2" x 60"	2410-OT 3-1/2" x 48" 3-1/2" x 60"	2442-TAP 3-1/2" x 48" 3-1/2" x 60"	2442-OCT 3-1/2" x 48" 3-1/2" x 60"	2442-TW 3-1/2" x 48" 3-1/2" x 60"	2442-OT 3-1/2" x 48" 3-1/2" x 60"
---	---	--	--	---	---	--	--

This series available in octagon by special order.
(Excluding # 5205P & #5200P)

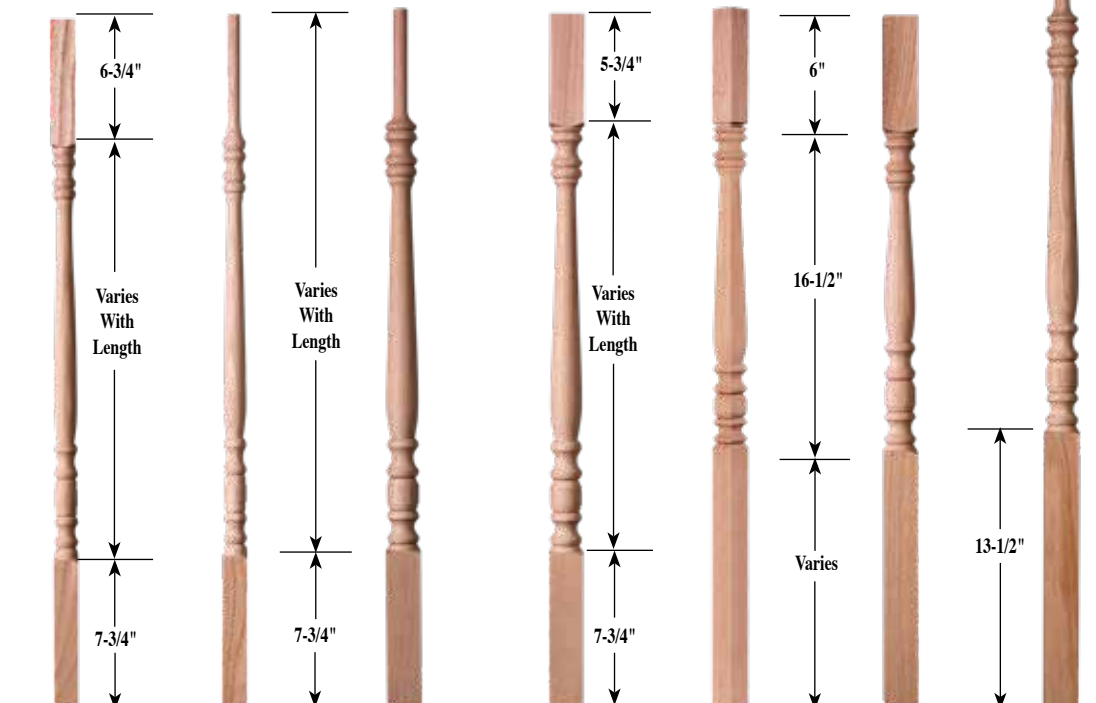

5205-P 1-1/4" x 31" 1-1/4" x 34" 1-1/4" x 36" 1-1/4" x 39" 1-1/4" x 41"	5200-P 1-1/4" x 31" 1-1/4" x 34" 1-1/4" x 36" 1-1/4" x 39" 1-1/4" x 41"	5300-P 1-3/4" x 31" 1-3/4" x 34" 1-3/4" x 36" 1-3/4" x 39" 1-3/4" x 41"	5105-P 1-3/4" x 31" 1-3/4" x 34" 1-3/4" x 36" 1-3/4" x 39" 1-3/4" x 41"	5005-SQ (No Dowel) 1-3/4" x 31" 1-3/4" x 36" 1-3/4" x 41"	5005-P (No Dowel) 1-3/4" x 31" 1-3/4" x 36" 1-3/4" x 41"	5300-LB (No Dowel) 41"
---	---	---	---	--	---	-------------------------------------

Available in most species

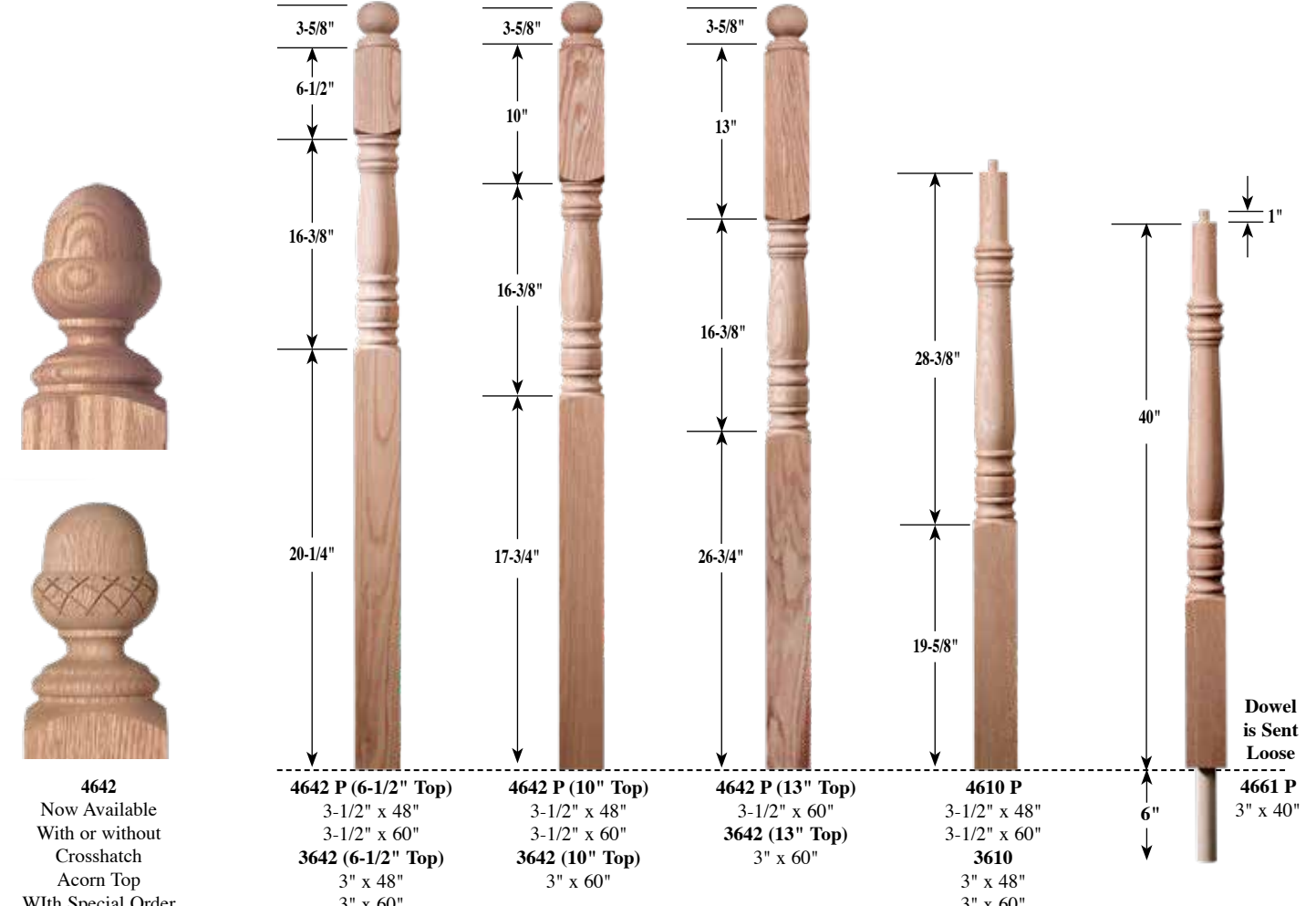

4642 Now Available With or without Crosshatch Acorn Top With Special Order	4642 P (6-1/2" Top) 3-1/2" x 48" 3-1/2" x 60" 3642 (6-1/2" Top) 3" x 48" 3" x 60"	4642 P (10" Top) 3-1/2" x 48" 3-1/2" x 60" 3642 (10" Top) 3" x 48" 3" x 60"	4642 P (13" Top) 3-1/2" x 60" 3642 (13" Top) 3" x 60"	4610 P 3-1/2" x 48" 3-1/2" x 60" 3610 3" x 48" 3" x 60"	4661 P 3" x 40"
--	--	--	--	--	---------------------------

 This series available in octagon by special order.

No Dowel 41" Only

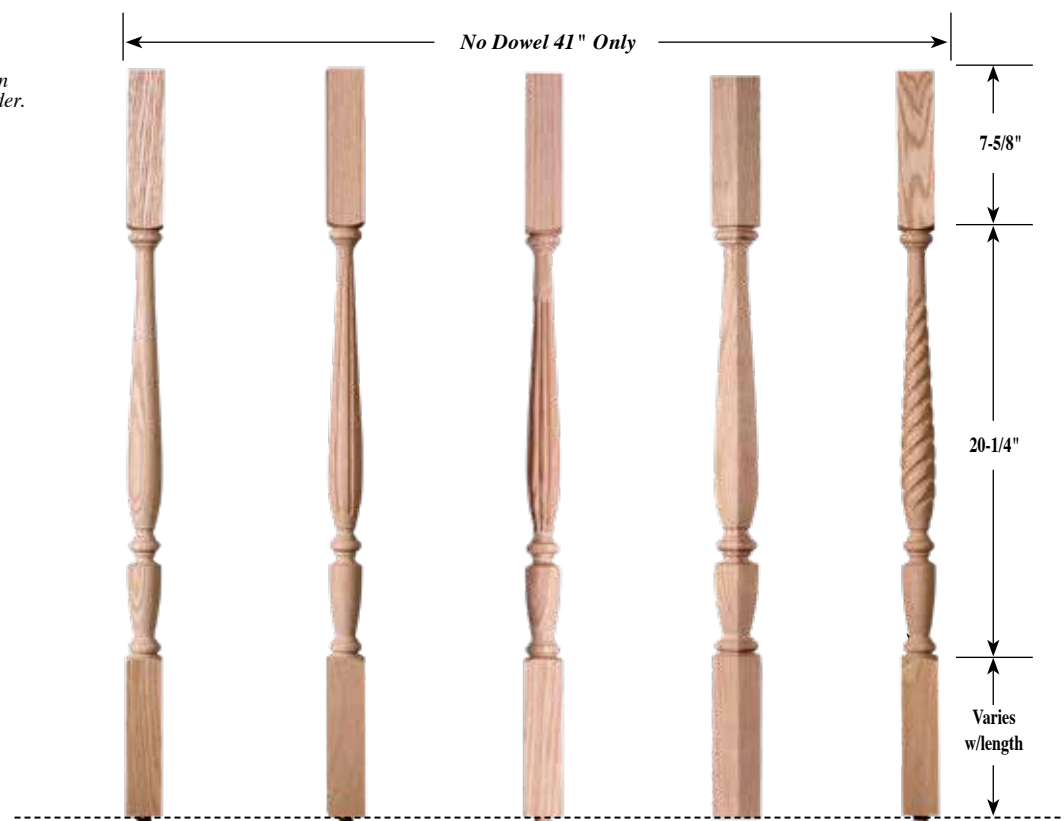

4405-P Plain 1-3/4" x 36" 1-3/4" x 41"	4405-F Fluted 1-3/4" x 36" 1-3/4" x 41"	4405-R Reeded 1-3/4" x 36" 1-3/4" x 41"	4405-SQ Square 1-3/4" x 36" 1-3/4" x 41"	4405-T Twisted 1-3/4" x 36" 1-3/4" x 41"
---	--	--	---	---

800-364-3269

Top extends with longer lengths

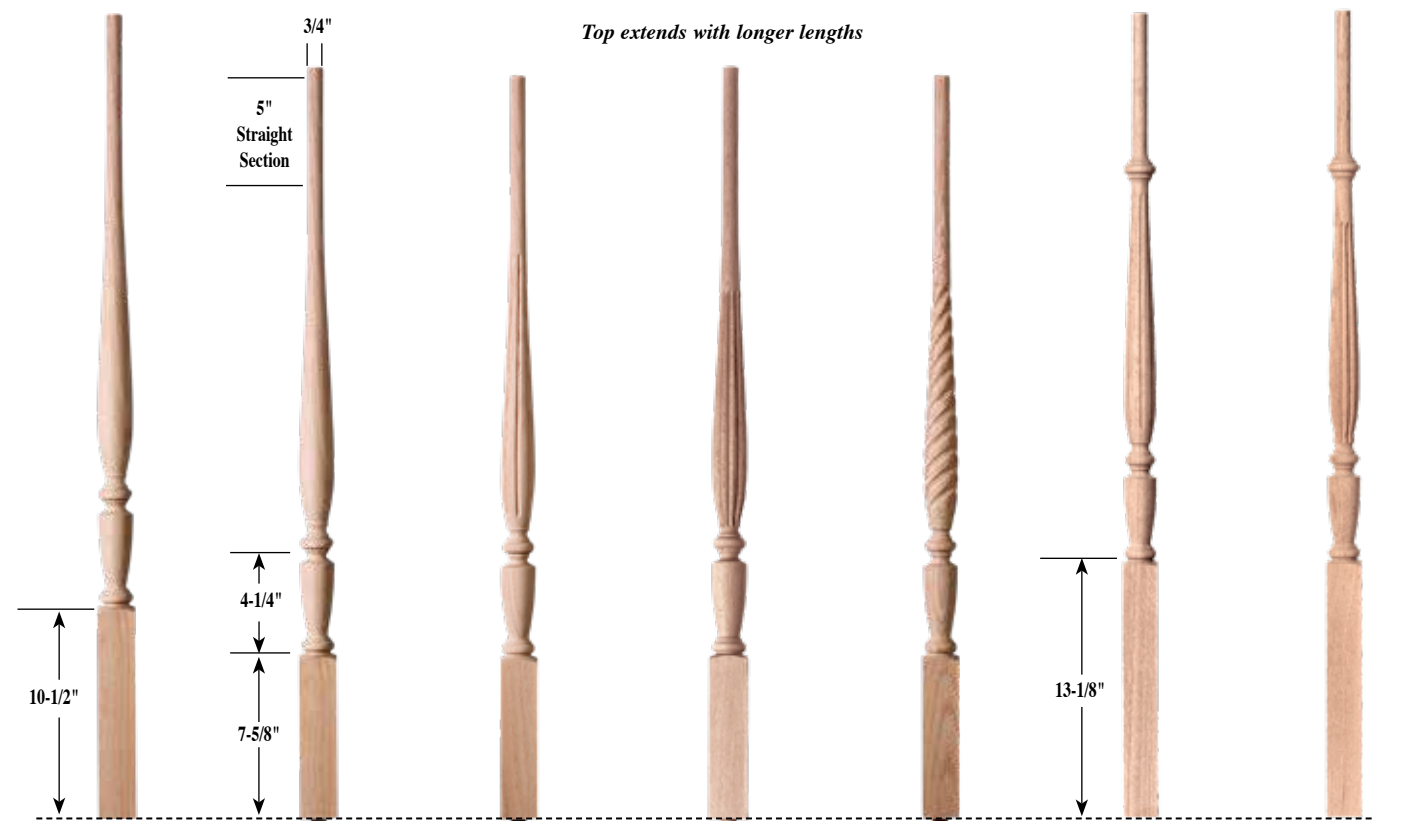

4415-LB 41" Available in Plain, Twisted, Fluted or Reeded (No Dowel)	4415-P Plain 1-3/4" x 3X" 1-3/4" x 39" 1-3/4" x 41"	4415-F Fluted 1-3/4" x 3X" 1-3/4" x 39" 1-3/4" x 41"	4415-R Reeded 1-3/4" x 3X" 1-3/4" x 39" 1-3/4" x 41"	4415-T Twisted 1-3/4" x 3X" 1-3/4" x 39" 1-3/4" x 41"	4417-F Fluted 1-3/4" x 41" LB (No Dowel)	4417-R Reeded 1-3/4" x 41" LB
--	---	--	--	---	--	---

Also Available in Plain

Available in most species

 This series available in octagon by special order.



4442
Now Available With or without Crosshatch Acorn Top With Special Order

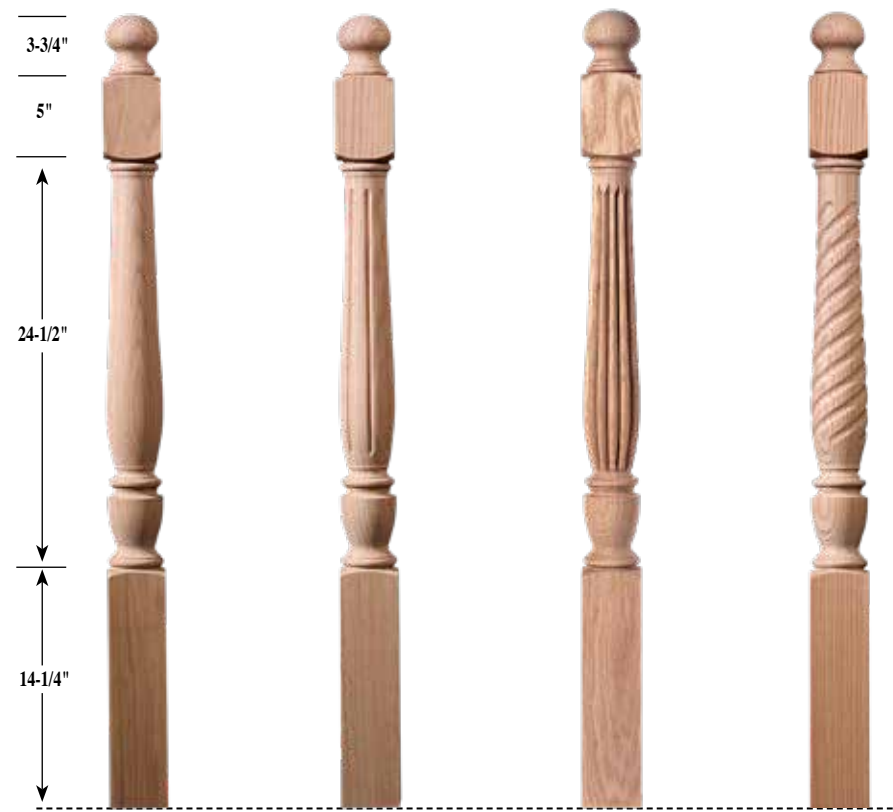

4442-P Plain 3-1/2" x 48" 3-1/2" x 60"	4442-F Fluted 3-1/2" x 48" 3-1/2" x 60"	4442-R Reeded 3-1/2" x 48" 3-1/2" x 60"	4442-T Twisted 3-1/2" x 48" 3-1/2" x 60"
---	--	--	---

When ordering #4442 series, please specify 5", 10", or 13" top. 10" & 13" Top Available in 60" Only



4410-P Plain 3-1/2" x 48" 3-1/2" x 60"	4410-F Fluted 3-1/2" x 48" 3-1/2" x 60"	4410-R Reeded 3-1/2" x 48" 3-1/2" x 60"	4410-T Twisted 3-1/2" x 48" 3-1/2" x 60"	4410-RT Reed Twist 3-1/2" x 48" 3-1/2" x 60"	4461-P Plain 3" x 41"	4461-F Fluted 3" x 41"	4461-R Reeded 3" x 41"	4461-T Twisted 3" x 41"
---	--	--	---	---	---------------------------------	----------------------------------	----------------------------------	-----------------------------------

Dowel is sent loose.

By Special Order

800-364-3269

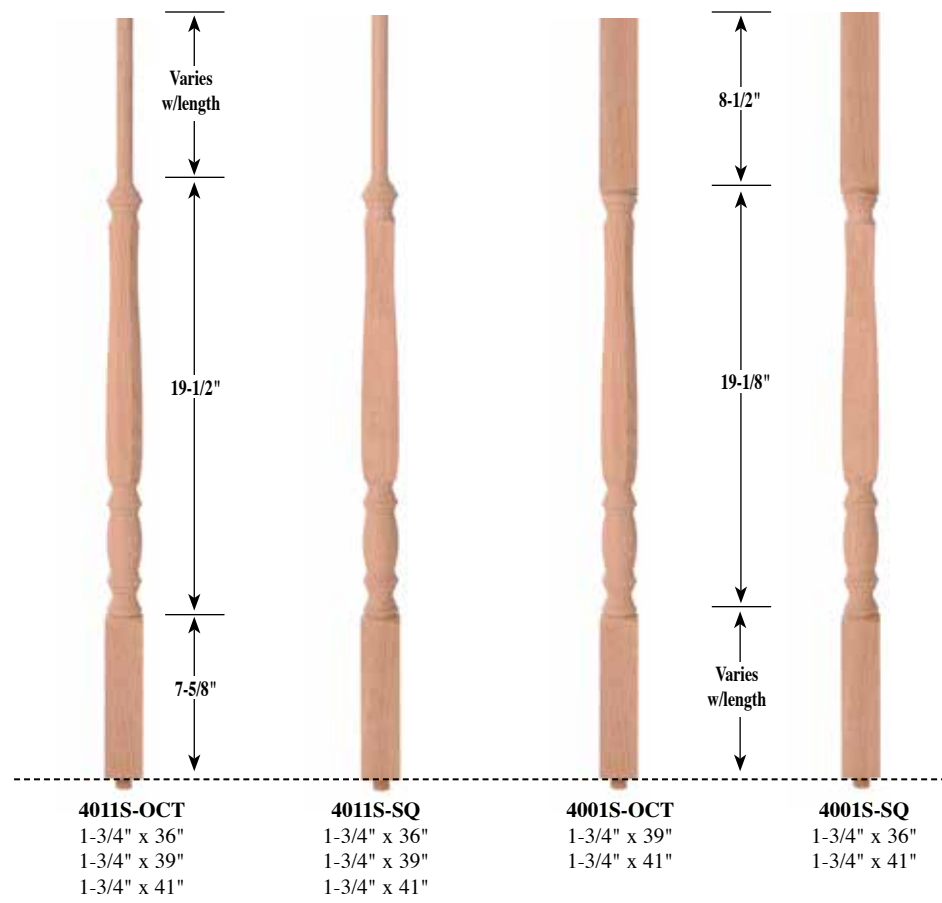

4011S-OCT 1-3/4" x 36" 1-3/4" x 39" 1-3/4" x 41"	4011S-SQ 1-3/4" x 36" 1-3/4" x 39" 1-3/4" x 41"	4001S-OCT 1-3/4" x 39" 1-3/4" x 41"	4001S-SQ 1-3/4" x 36" 1-3/4" x 41"
--	---	--	---

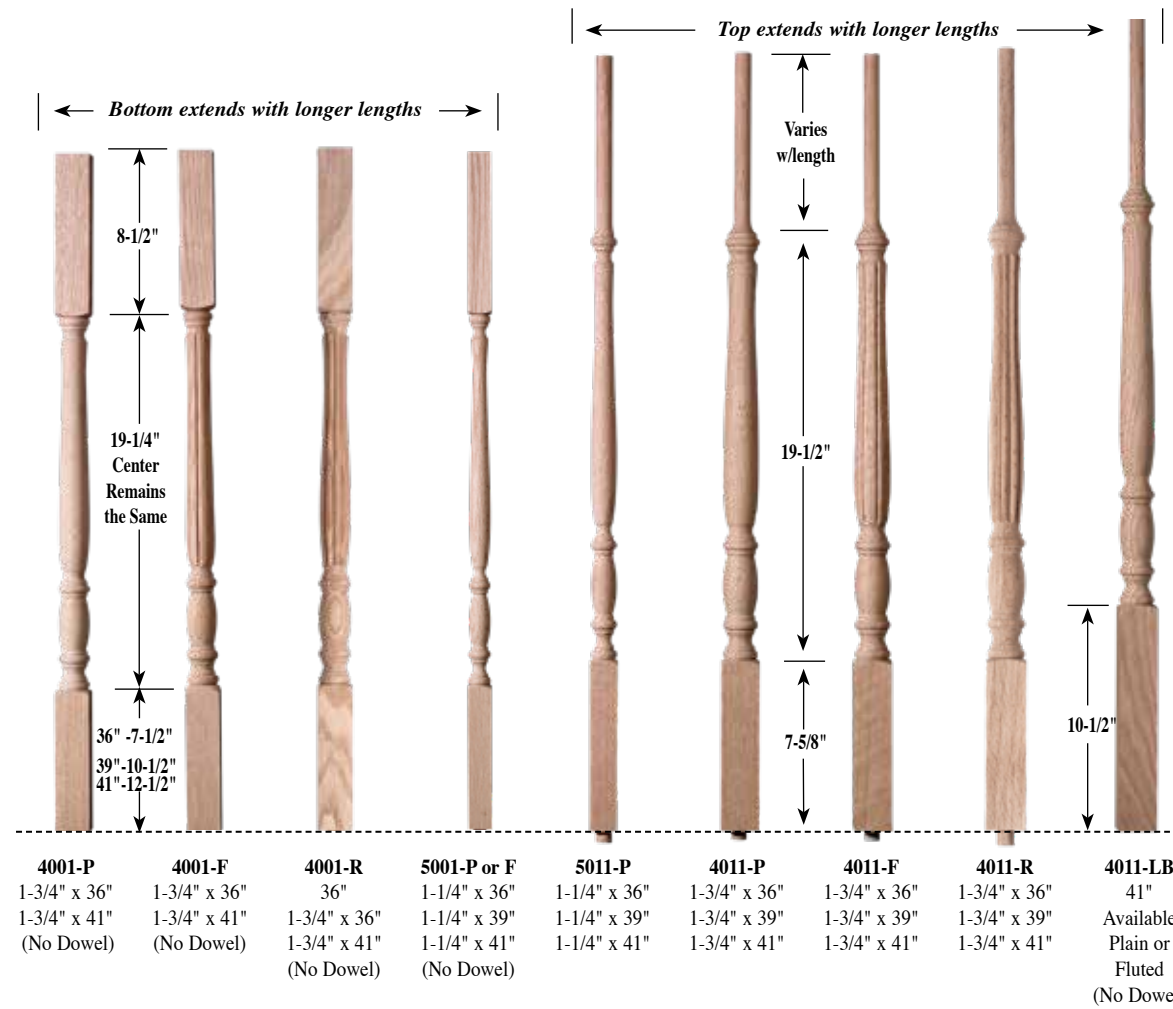

4001-P 1-3/4" x 36" 1-3/4" x 41" (No Dowel)	4001-F 1-3/4" x 36" 1-3/4" x 41" (No Dowel)	4001-R 36" 1-3/4" x 36" (No Dowel)	5001-P or F 1-1/4" x 36" 1-1/4" x 39" (No Dowel)	5011-P 1-1/4" x 36" 1-1/4" x 39" 1-1/4" x 41"	4011-P 1-3/4" x 36" 1-3/4" x 39" 1-3/4" x 41"	4011-F 1-3/4" x 36" 1-3/4" x 39" 1-3/4" x 41"	4011-R 1-3/4" x 36" 1-3/4" x 39" 1-3/4" x 41"	4011-LB 41" Available Plain or Fluted (No Dowel)
---	---	--	--	---	---	---	---	--

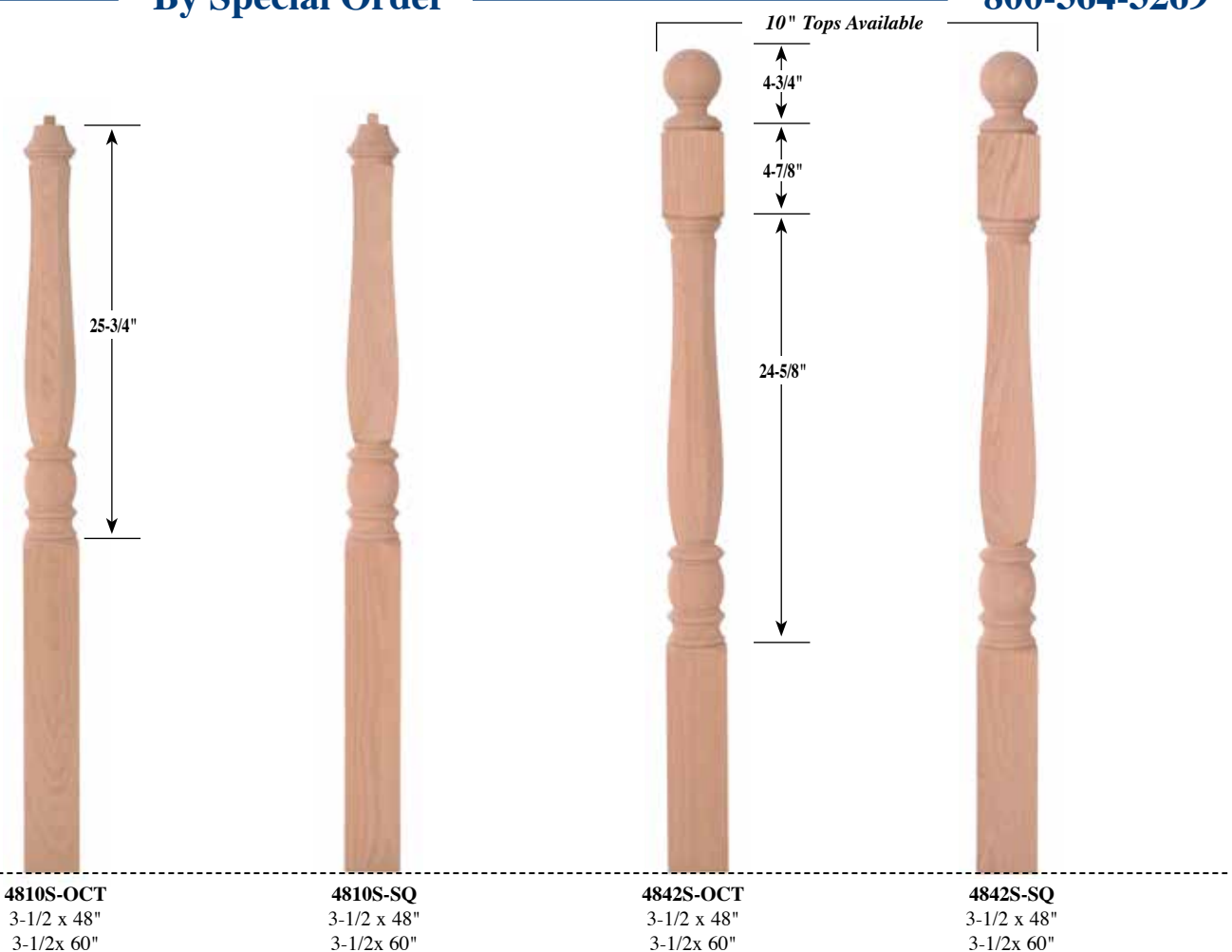

4810S-OCT 3-1/2" x 48" 3-1/2" x 60"	4810S-SQ 3-1/2" x 48" 3-1/2" x 60"	4842S-OCT 3-1/2" x 48" 3-1/2" x 60"	4842S-SQ 3-1/2" x 48" 3-1/2" x 60"
--	---	--	---

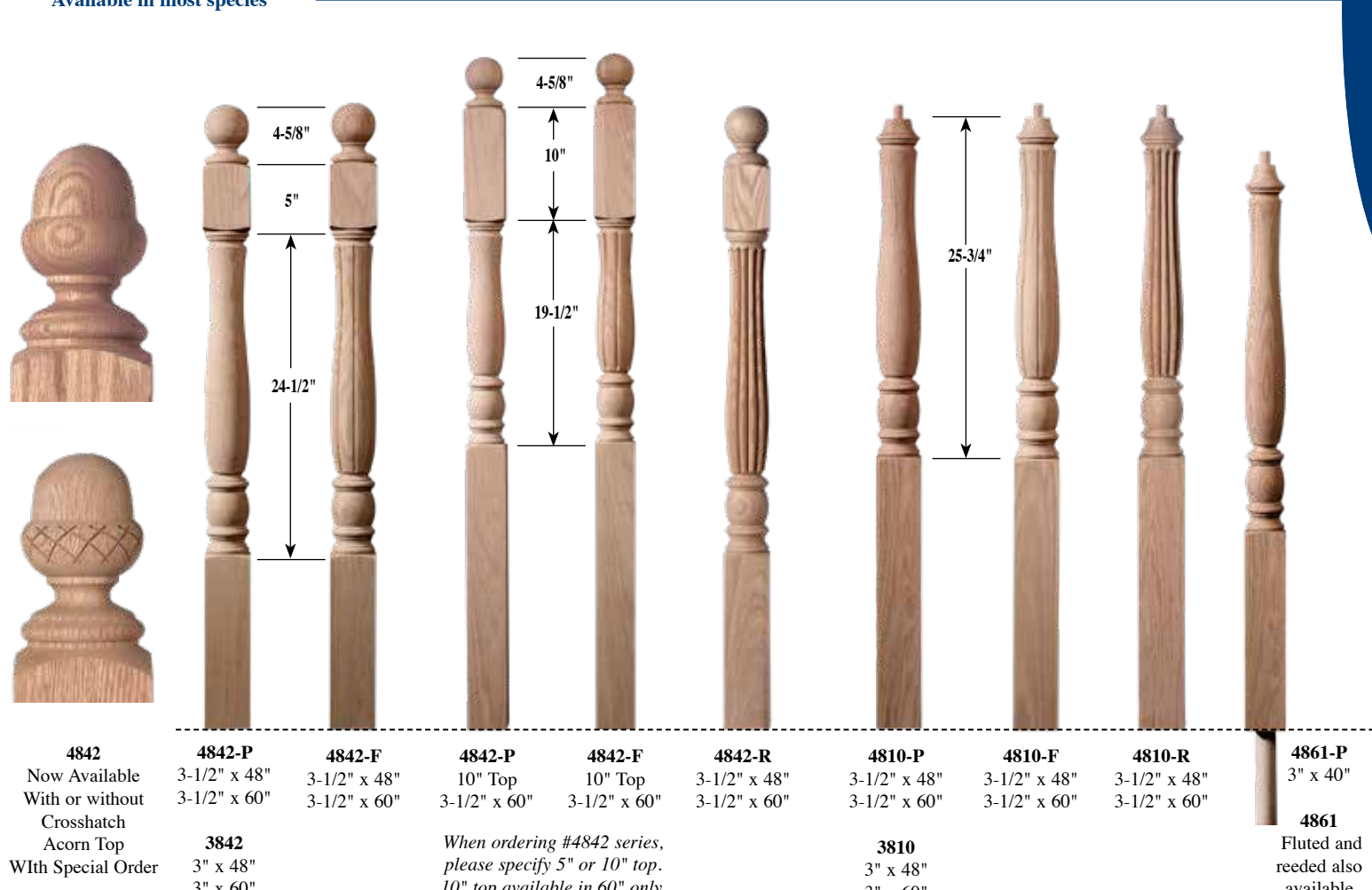

4842 Now Available With or without Crosshatch Acorn Top With Special Order	4842-P 3-1/2" x 48" 3-1/2" x 60"	4842-F 3-1/2" x 48" 3-1/2" x 60"	4842-P 10" Top 3-1/2" x 60"	4842-F 10" Top 3-1/2" x 60"	4842-R 3-1/2" x 48" 3-1/2" x 60"	4810-P 3-1/2" x 48" 3-1/2" x 60"	4810-F 3-1/2" x 48" 3-1/2" x 60"	4810-R 3-1/2" x 48" 3-1/2" x 60"	4861-P 3" x 40" Fluted and reeded also available
--	---	---	--	--	---	---	---	---	---

When ordering #4842 series, please specify 5" or 10" top. 10" top available in 60" only.

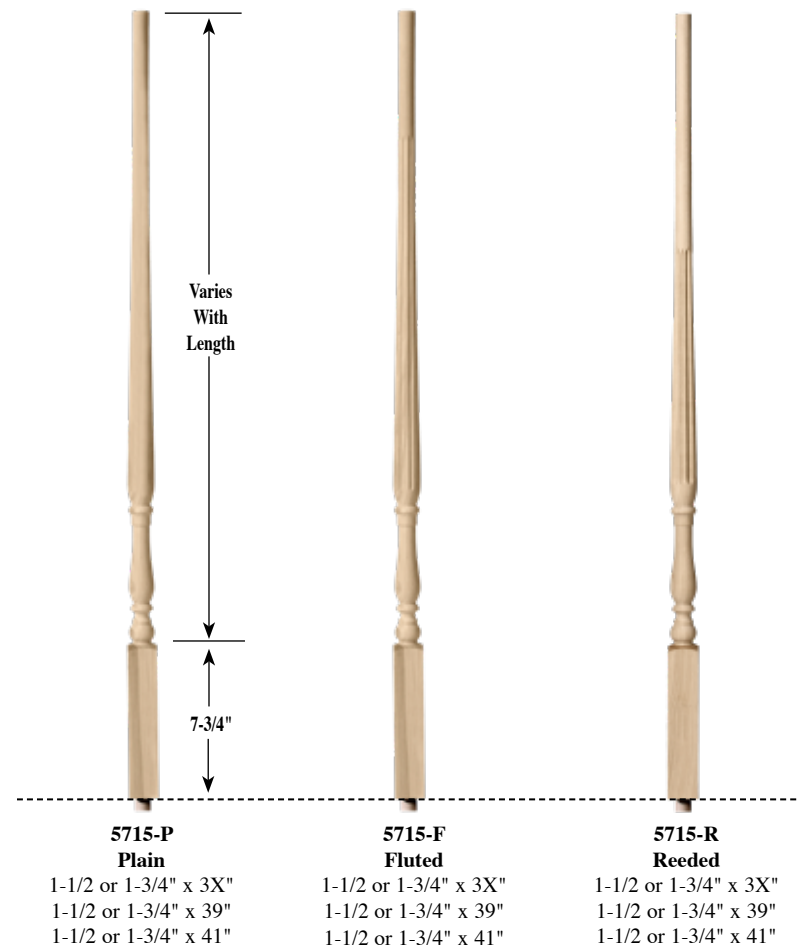

5715-P Plain
1-1/2 or 1-3/4" x 3X"
1-1/2 or 1-3/4" x 39"
1-1/2 or 1-3/4" x 41"

5715-F Fluted
1-1/2 or 1-3/4" x 3X"
1-1/2 or 1-3/4" x 39"
1-1/2 or 1-3/4" x 41"

5715-R Reeded
1-1/2 or 1-3/4" x 3X"
1-1/2 or 1-3/4" x 39"
1-1/2 or 1-3/4" x 41"

800-364-3269

Below are examples of the newel top options that are available for the items in our Traditional line of Wood Stair Parts.

All traditional balusters can be fluted, twisted, or reeded upon request.

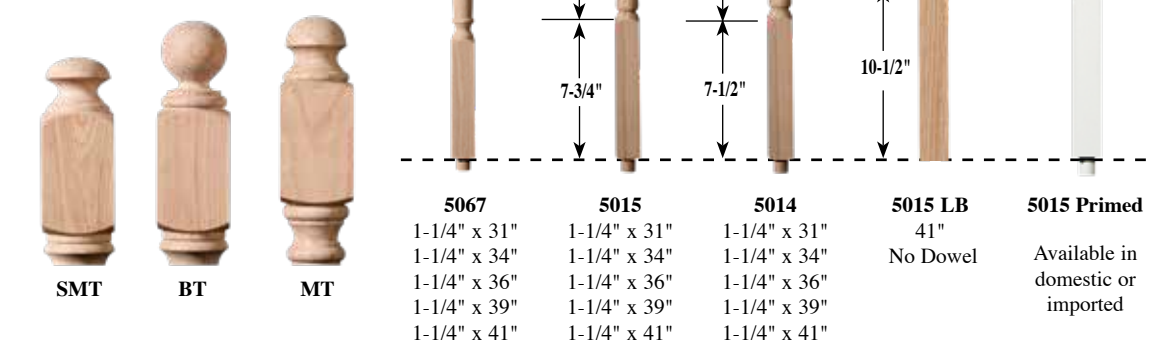

SMT **BT** **MT**

5067
1-1/4" x 31"
1-1/4" x 34"
1-1/4" x 36"
1-1/4" x 39"
1-1/4" x 41"

5015
1-1/4" x 31"
1-1/4" x 34"
1-1/4" x 36"
1-1/4" x 39"
1-1/4" x 41"

5014
1-1/4" x 31"
1-1/4" x 34"
1-1/4" x 36"
1-1/4" x 39"
1-1/4" x 41"

5015 LB
41"
No Dowel

5015 Primed
Available in domestic or imported

Available in most species

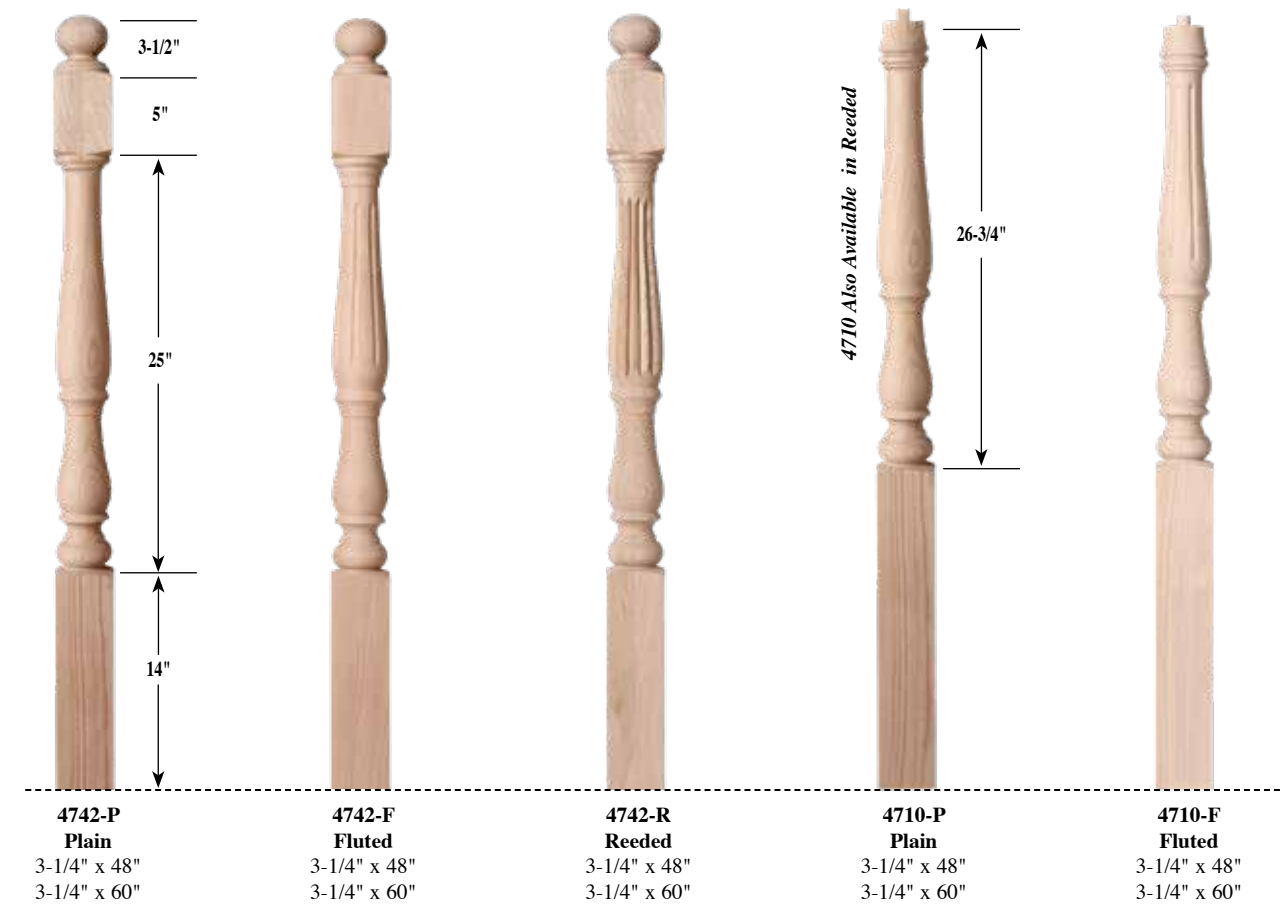

4742-P Plain
3-1/4" x 48"
3-1/4" x 60"

4742-F Fluted
3-1/4" x 48"
3-1/4" x 60"

4742-R Reeded
3-1/4" x 48"
3-1/4" x 60"

4710-P Plain
3-1/4" x 48"
3-1/4" x 60"

4710-F Fluted
3-1/4" x 48"
3-1/4" x 60"

60" Available in 5", 10" or 13" Top Block Please specify when ordering.
Newels Also Available in 3-1/2" by Special Order.

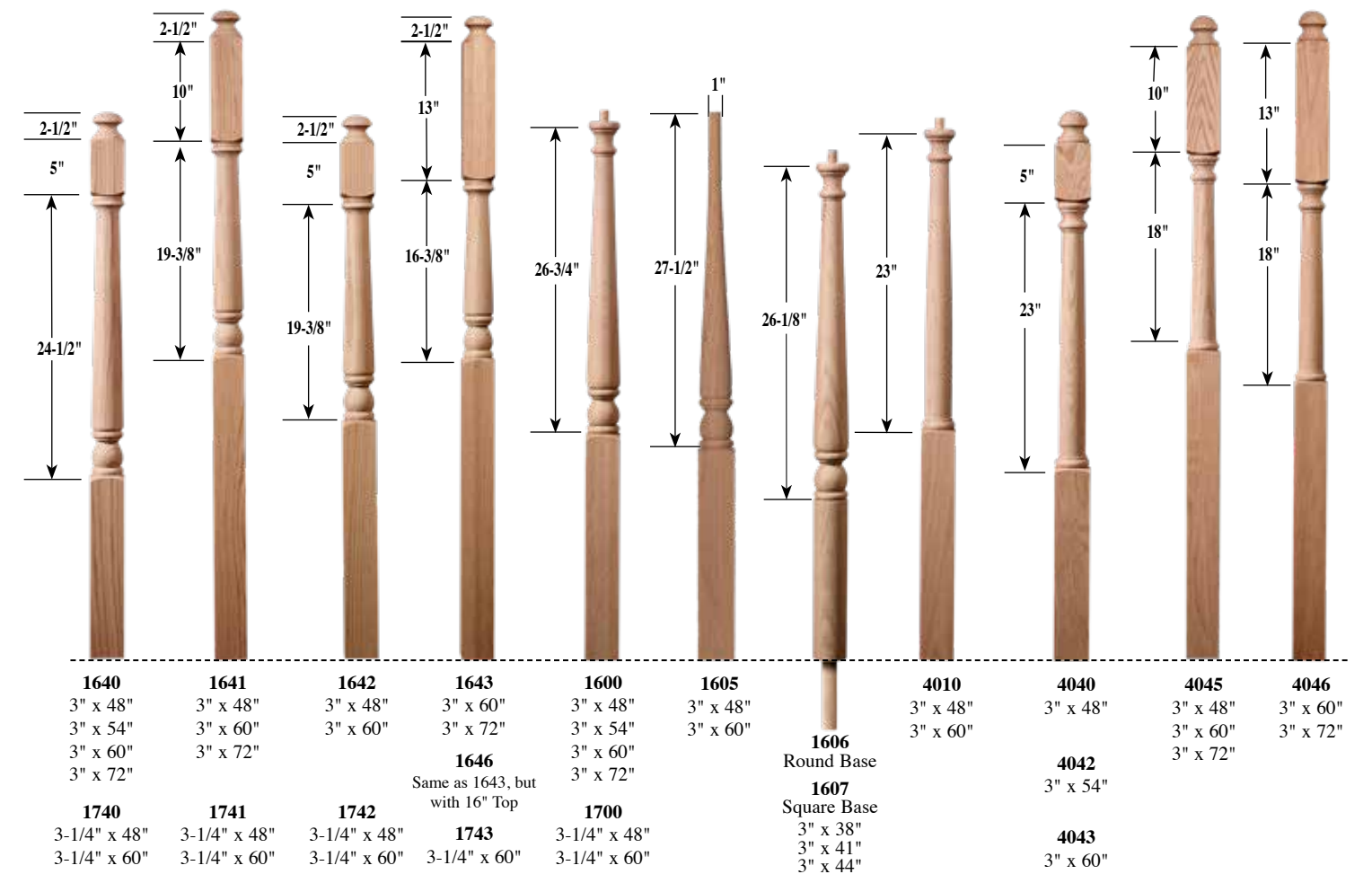

1640
3" x 48"
3" x 54"
3" x 60"
3" x 72"

1641
3" x 48"
3" x 60"
3" x 72"

1642
3" x 48"
3" x 60"

1643
3" x 60"
3" x 72"

1646
Same as 1643, but with 16" Top

1600
3" x 48"
3" x 54"
3" x 60"
3" x 72"

1605
3" x 48"
3" x 60"

1606
Round Base

1607
Square Base

4010
3" x 48"
3" x 60"

4040
3" x 48"

4042
3" x 54"

4043
3" x 60"

4045
3" x 48"
3" x 60"
3" x 72"

4046
3" x 60"
3" x 72"

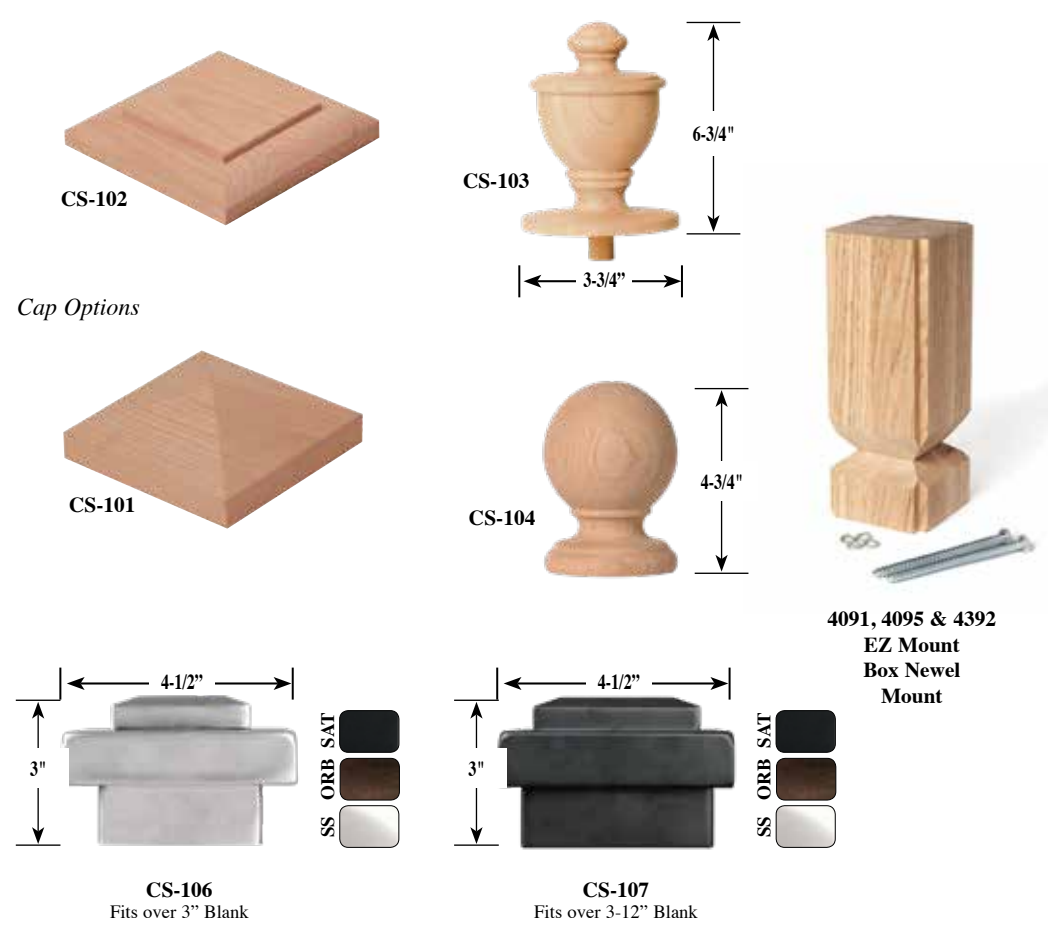
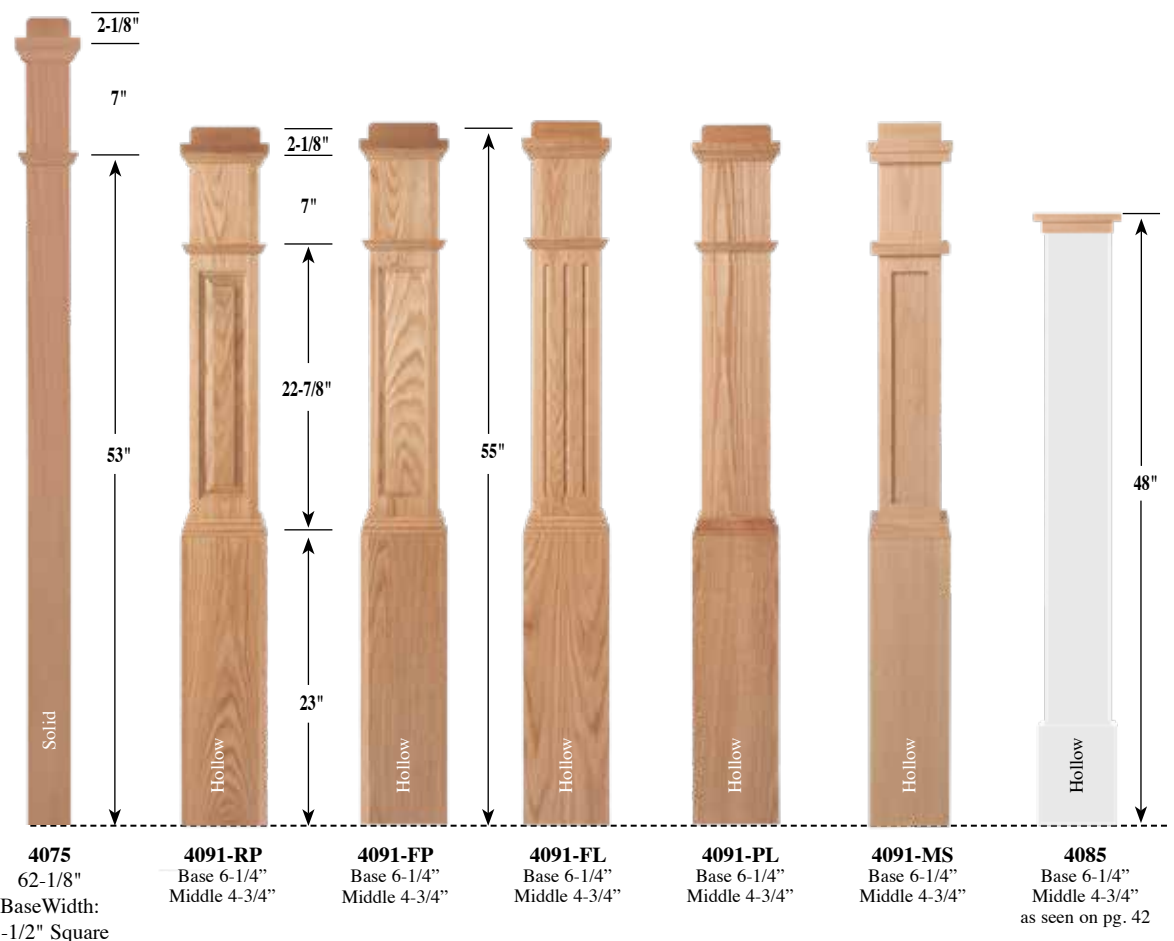

4091 Caps for Box Newels.
Can make virtually any fitting.
Customer must specify



800-364-3269

Available in most species

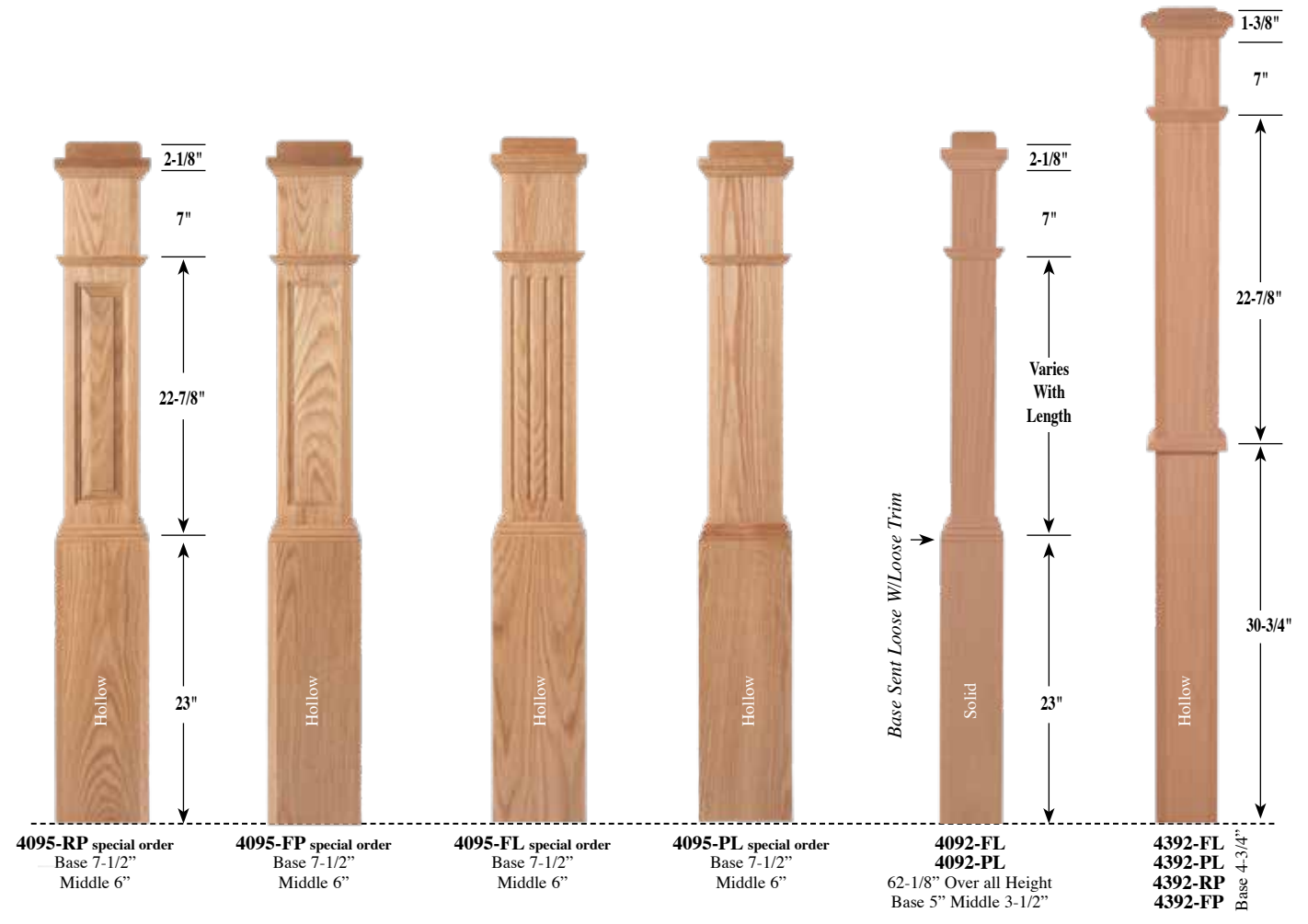

<p>#70 6010 Traditional Bending Rail 6010 B 7 Pieces</p>	<p>#71 6115 Mid-Western Bending Rail 6115 B 8 Pieces</p>	<p>#72 6210 Traditional Bending Rail 6210 B 8 Pieces</p>	<p>#73 6300 Carolina Bending Rail 6300 B</p>	<p>6005</p>	<p>Bending Rail & Fittings Available 6410 Williamsport</p>				
<p>#75 6519 Hampton Bending Rail 6519 B 8 Pieces</p>	<p>#76 6600 Raleigh Bending Rail 6600 B 10 Pieces</p>	<p>#77 6700 Georgian Bending Rail 6700 B 8 Pieces</p>	<p>#78 6800 Charleston Bending Rail 6800 B 8 Pieces</p>	<p>Bending Rail & Fittings Available 8100 Savannah</p>	<p>Bending Rail & Fittings Available 8200 Colonial</p>	<p>Bending Rail & Fittings Available 8300 Newport</p>			
<p>#79 6900 Raleigh Jr. Bending Rail 6900 B 8 Pieces</p>	<p>Bending Rail & Fittings Available 6000 For Plowed Please Specify 1-3/4\" or 1-1/4\"</p>	<p>6025 r = 3/8\" 3-1/2\" 5-1/2\" 1-5/8\" 1-5/8\" With Finger Groove Contemporary Rail (Fittings Not Available) 6026 W/Out Finger Groove</p>	<p>Bending Rail & Fittings Available 6084 1-3/4\" 1-5/8\" Modern</p>	<p>9400 2\" 1-1/4\" 1-3/4\"</p>	<p>9500 2-1/2\"</p>	<p>9600 3\" 2-1/4\" 2-1/4\"</p>	<p>9700 1-3/4\" 1-5/8\"</p>		
<p>8400 1-3/8\" 1\"</p>	<p>8500 2-5/16\" 2\"</p>		<p>Bending Rail & Fittings Available 8700 2-1/8\" 2-1/4\"</p>	<p>Bending Rail & Fittings Available R-1 2-1/8\" 1-3/4\"</p>	<p>Bending Rail & Fittings Available R-2 2-7/8\" 2-3/8\"</p>	<p>Bending Rail & Fittings Available R-3 1-3/4\" 2-1/16\"</p>			
<p>Bending Rail & Fittings Available 8800 3-1/2\" 1-9/16\"</p>	<p>Bending Rail & Fittings Available 8900 2\" 2-1/16\"</p>	<p>Bending Rail & Fittings Available 9100 2-1/2\" 2-1/4\"</p>	<p>9200 2-1/4\" 1\"</p>	<p>Bending Rail & Fittings Available R-5 2-1/8\" 2-5/8\" 2-7/8\"</p>	<p>Bending Rail & Fittings Available R-6 3-1/16\" 2-3/8\"</p>	<p>Bending Rail & Fittings Available R-7 2-7/8\" 1-3/4\"</p>	<p>Bending Rail & Fittings Available R-8 2-1/2\" 1-3/4\"</p>		
<p>9000 3\" 1-3/4\"</p>	<p>9300 2-3/8\" 1-7/8\"</p>	<p>Bending Rail & Fittings Available R-4 Allied 2-3/8\" 2-5/8\" Allied</p>		<p>Bending Rail & Fittings Available R-9 2-1/4\" 2-3/16\"</p>	<p>Bending Rail & Fittings Available R-10 2-3/8\" 2-3/8\"</p>	<p>Bending Rail & Fittings Available R-11 2-1/4\" 2-5/8\"</p>	<p>Bending Rail & Fittings Available R-15 2-1/4\" 1-1/2\" Mincey</p>		

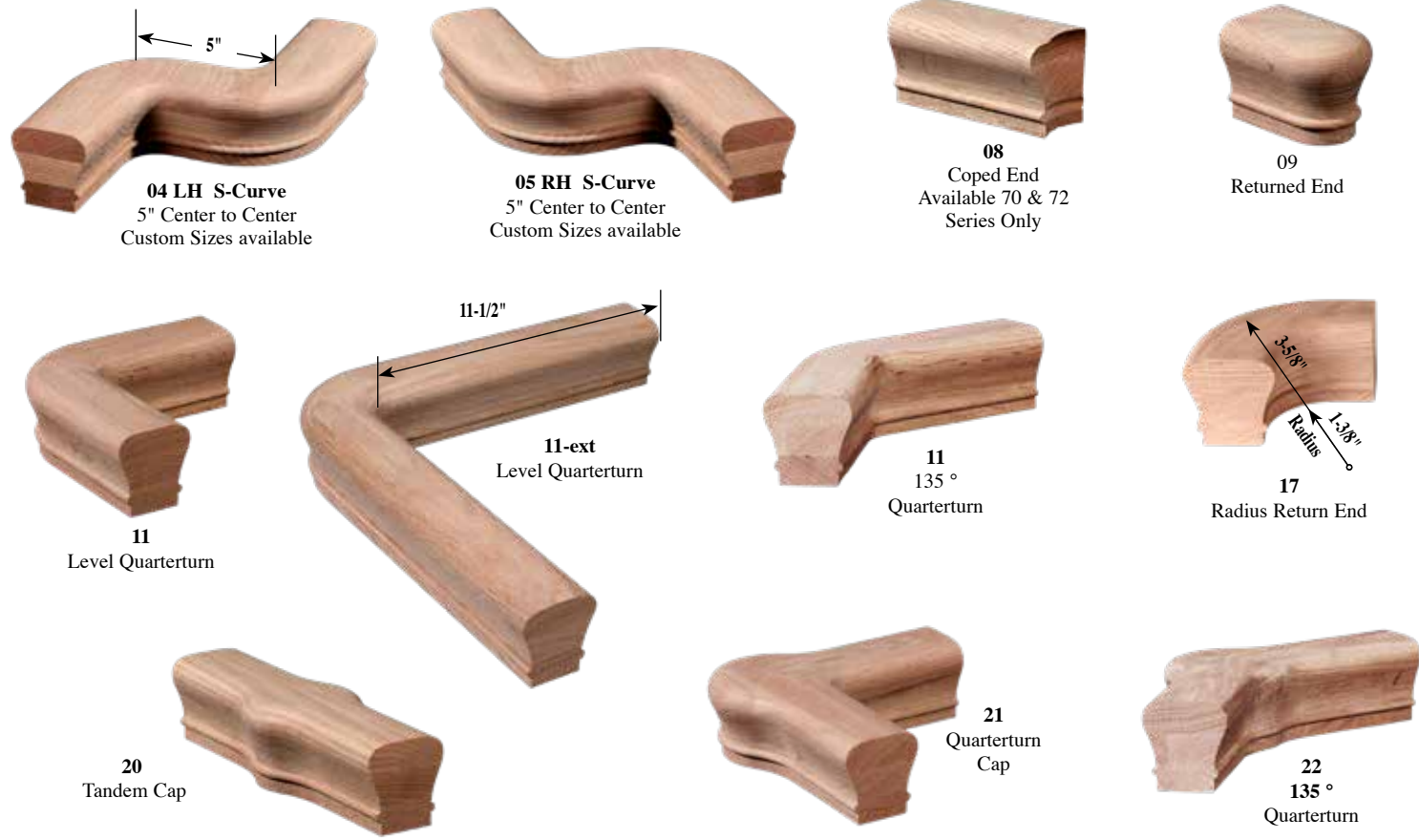

800-364-3269

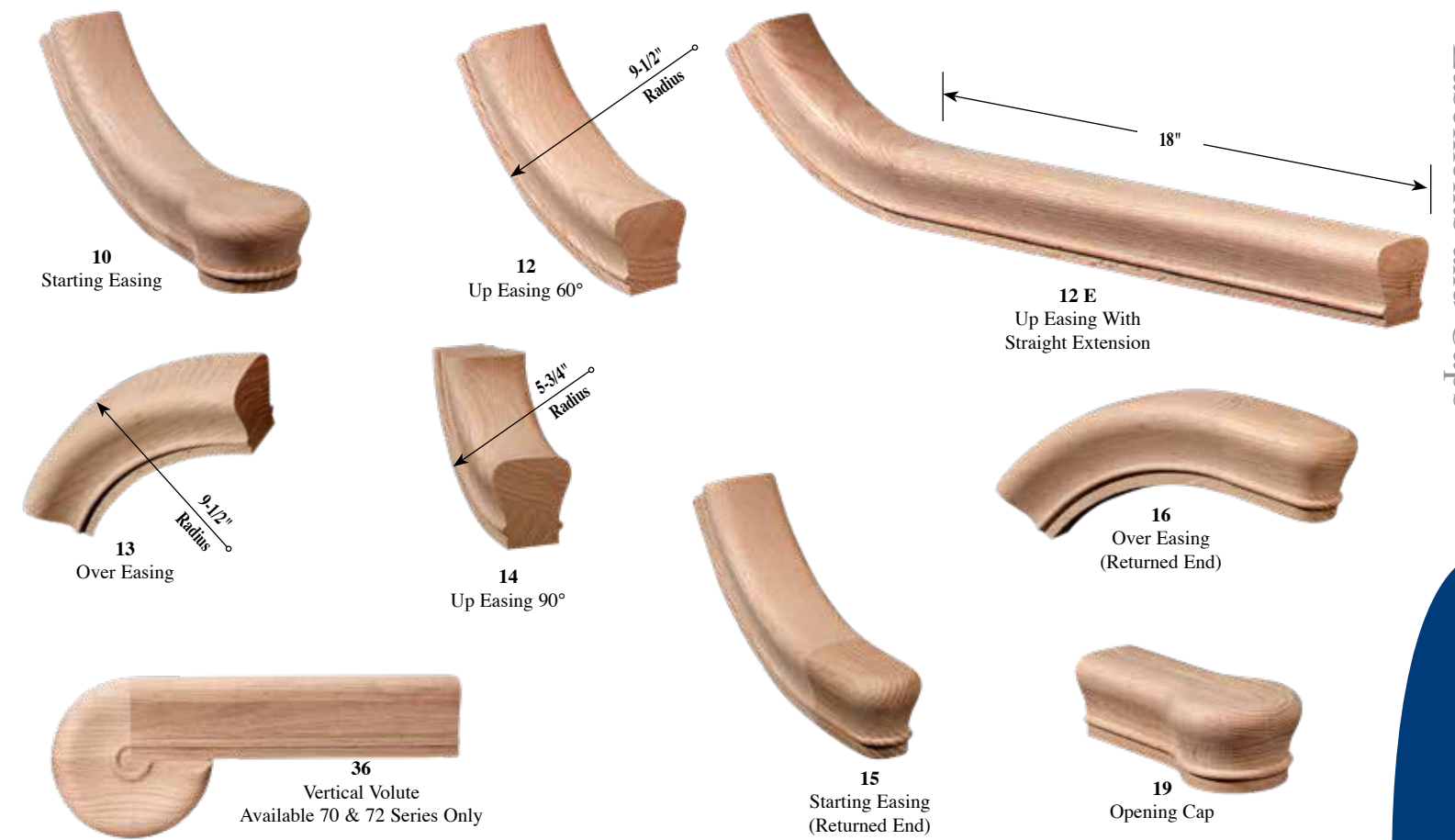

Available in most species



70 & 73 Series are 4-7/8" from center of newel to center of handrail.
All other profiles are 5-1/8".

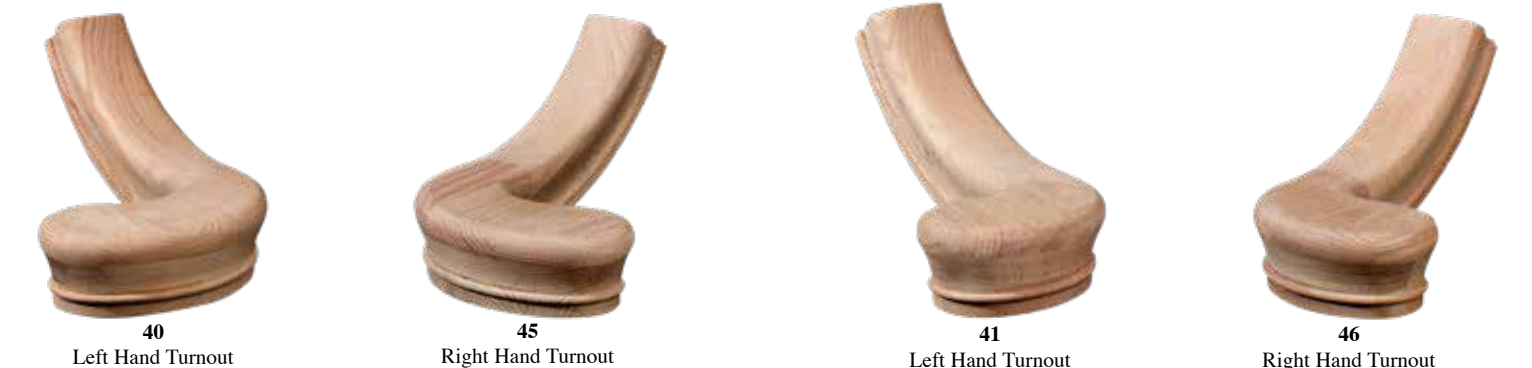

4-7/8" From Center of Newel to Center of Handrail

2-7/8" From Center of Newel to Center of Handrail

All goosenecks are shipped with easements unattached. Custom angles available on quarter turns. Well hole fittings are 5-1/2" from Center of Rail to Center of Rail

8085
Nosing
1-1/16" x 1-1/2"

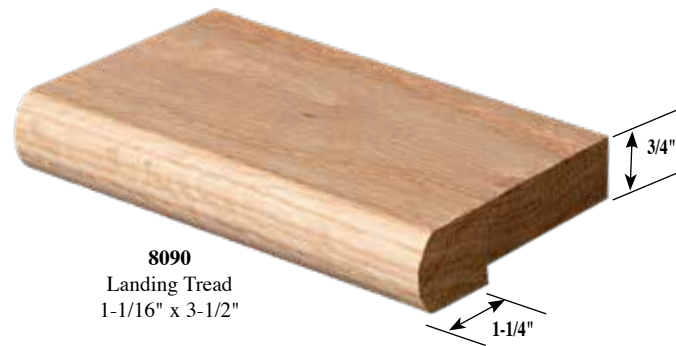

8090
Landing Tread
1-1/16" x 3-1/2"

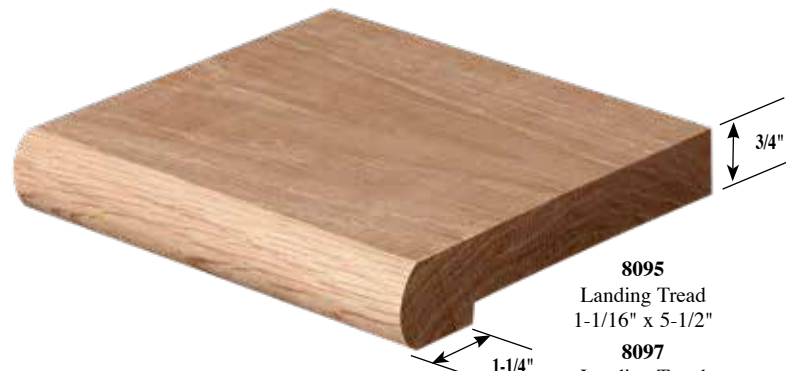

8095
Landing Tread
1-1/16" x 5-1/2"



6910 - Cove Mold
3/4" x 3/4"
6904 - Cove Mold
1/2" x 5/8"
6902 - Cove Mold
5/8" x 5/8"



6912
Stringer Mold
1-3/8" x 5/8"



6915
Stringer Cap
5/8" x 1/2"

Available Sizes
1-1/2"
1-3/4"
2"
2-3/8"
2-7/8"
2-1/8"
Fittings Now Available



RND-1
Round Rail
Special Order



6040
Wall Rail
1-1/2" x 1-1/2"



6042
Wall Rail
1-3/16" x 2-1/4"
Fittings Now Available
Easments & Quarterturns



6043
Wall Rail
1-3/4" x 1-5/8"

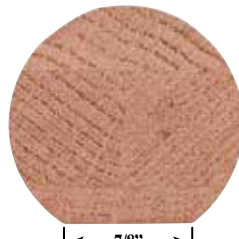

6044
Fusion Handrail
2-1/8" w x 2" h
7/8" Flat Bottom

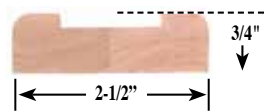

1001-MS



1000
Fillet
3/16" x 1-1/4"
3/16" x 1-3/4"



1001
Shoe Rail
3/4" x 3-1/8" x 1-3/4" Plow
3/4" x 2-3/8" x 1-1/4" Plow



1002
Flat Fillet
3/16" x 1-1/4"
3/16" x 1-3/4"



8010
Reversible Single
"Bull Nose" Starting Step
Specify: 36", 42", 48", 54" or 60"
Measurement is distance from "notch to notch."
Also available in bowed front.



8010 F
Reversible False End
Starting Step

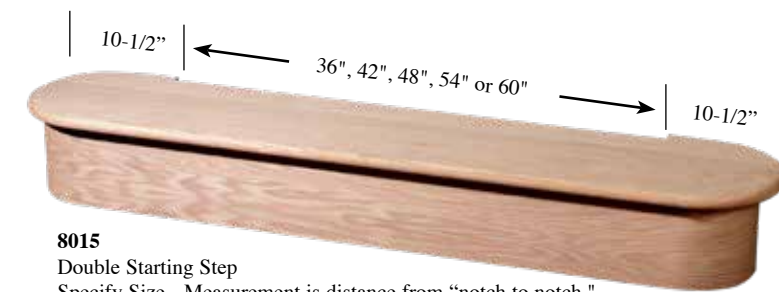

8015
Double Starting Step
Specify Size - Measurement is distance from "notch to notch."
Also available in bowed front.



8070
10-1/2" Tread
8071 11-1/2" Tread
Specify " 36", 42", 48" 54", 60" or 72"
1-1/2" Mitre Return: RH, LH or Double

8072, 8073, 8074, 8075 & 8076
Available prefinished in stock Minwax colors

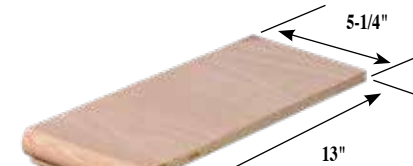

8072
False End
(No M.R.)

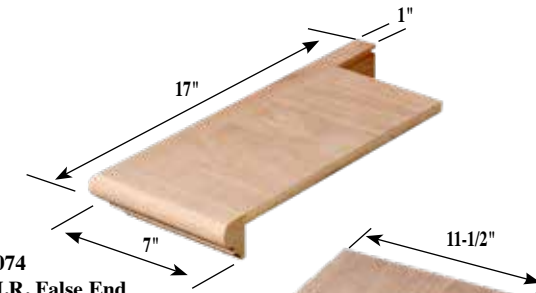

8074
M.R. False End
Specify: RH or LH

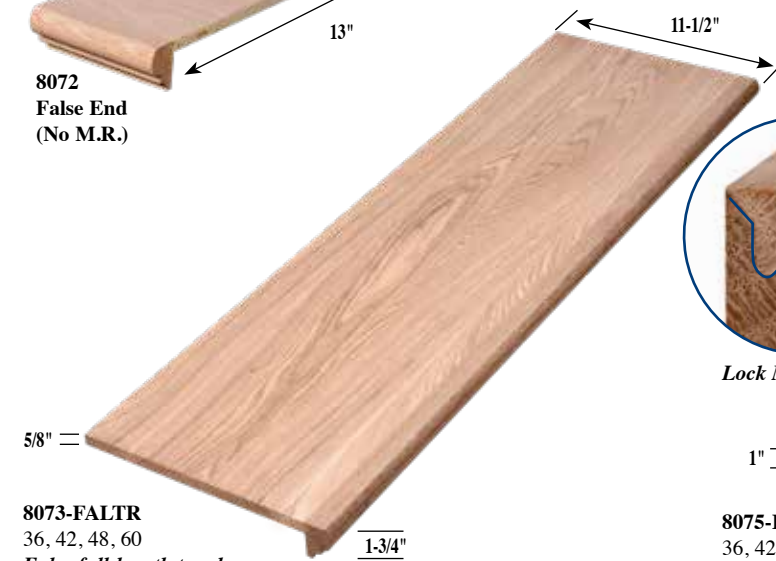

8073-FALTR
36, 42, 48, 60
False full-length tread.
Left hand or right hand available upon request.
Available prefinished in stock Minwax colors



Lock Mitre

8075-FALTR
36, 42, 48, 60
False full-length tread.
Left hand or right hand available upon request.

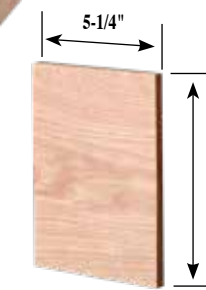

8076
False Riser
1/2" thick



Winder Tread Panels
8078-TPNL
1" x 25" x 42"
1" x 25" x 48"
1" x 25" x 60"



97 "STR" Stringer
1" or 3/4" thick



8080
Riser
Specify Size:
3/4" x 36", 42", 48", 54" or 60"
1 x 8" S4S 1 x 6" S4S 1 x 4" S4S

Custom Profiles

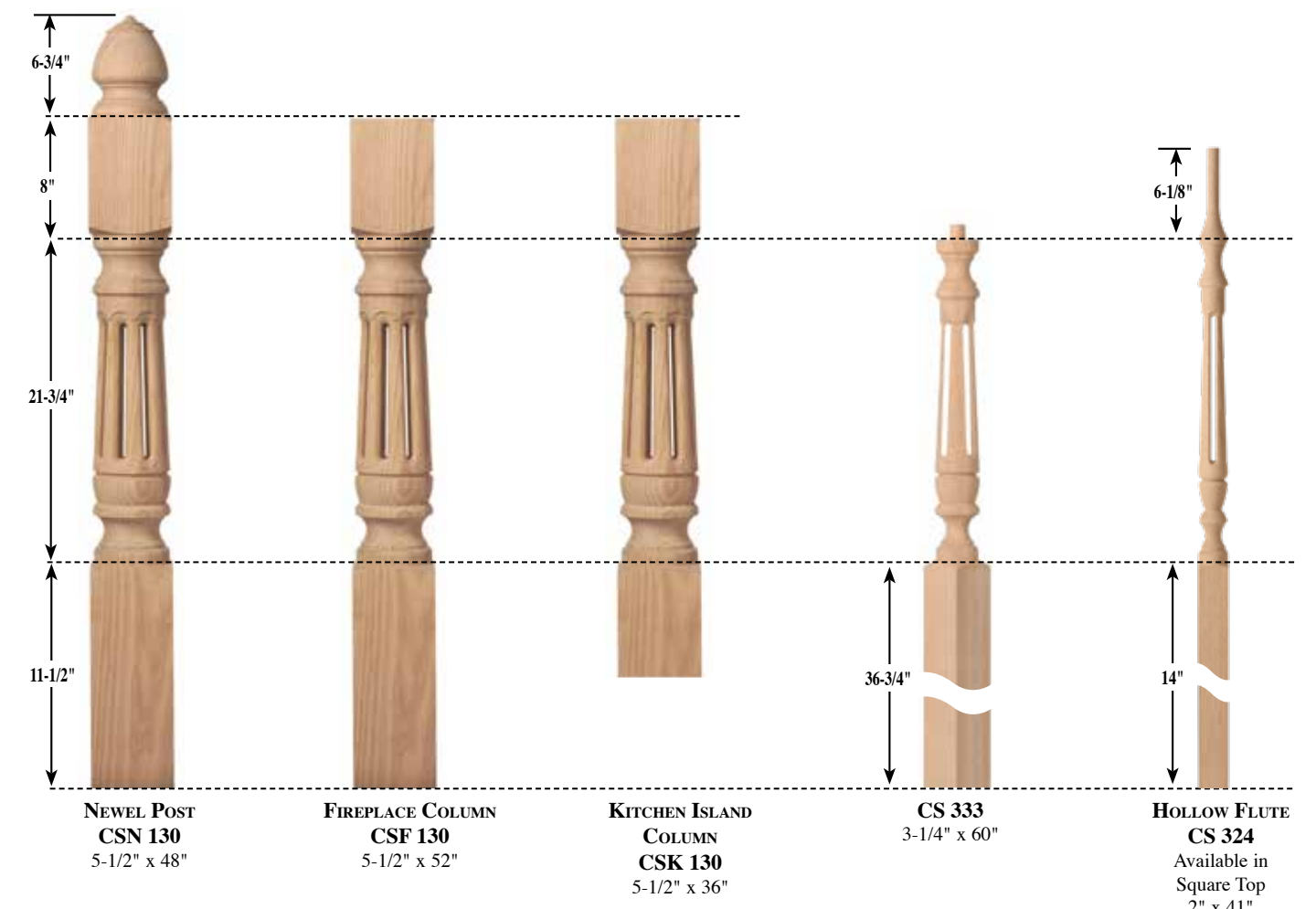
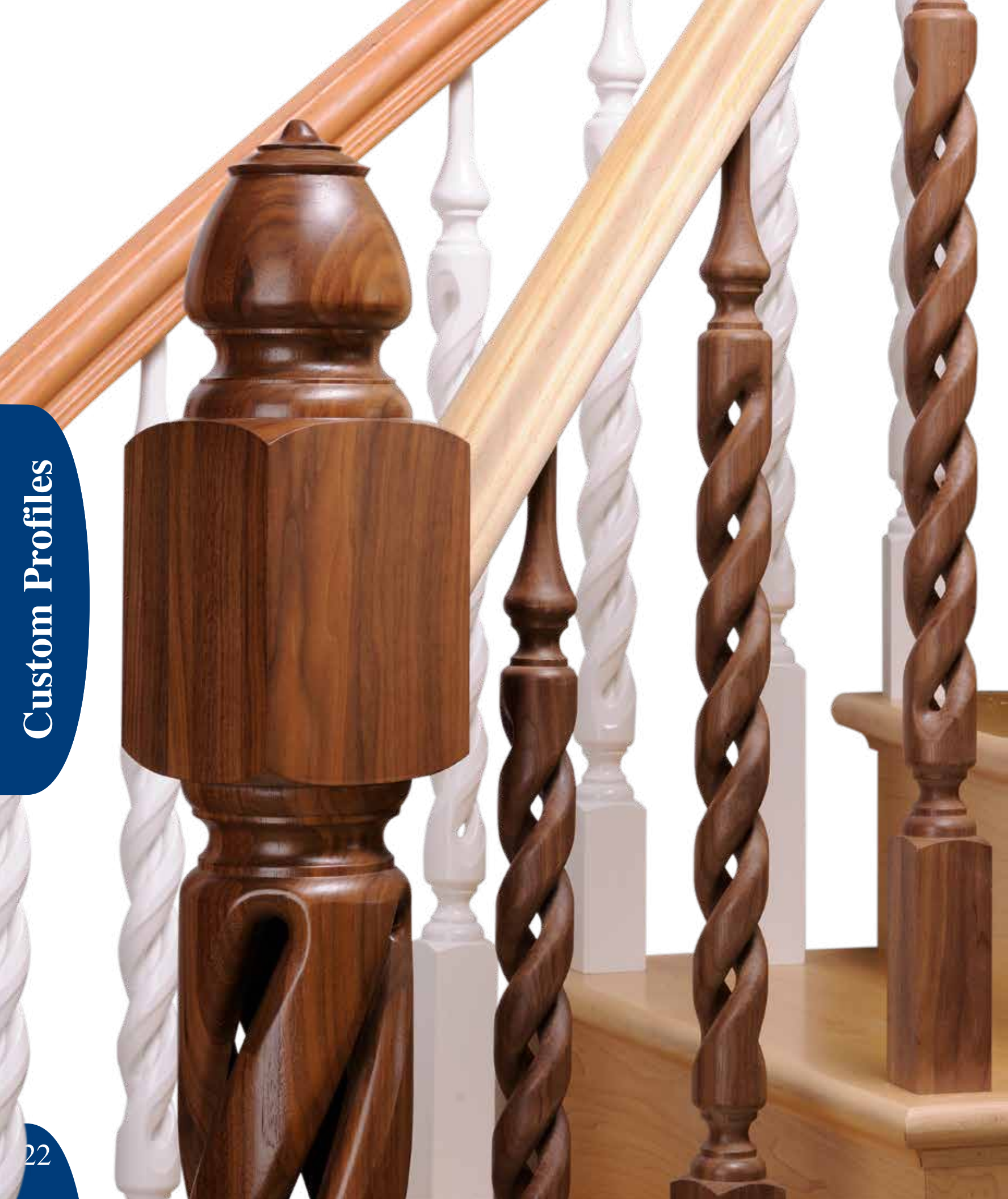

Available in most species

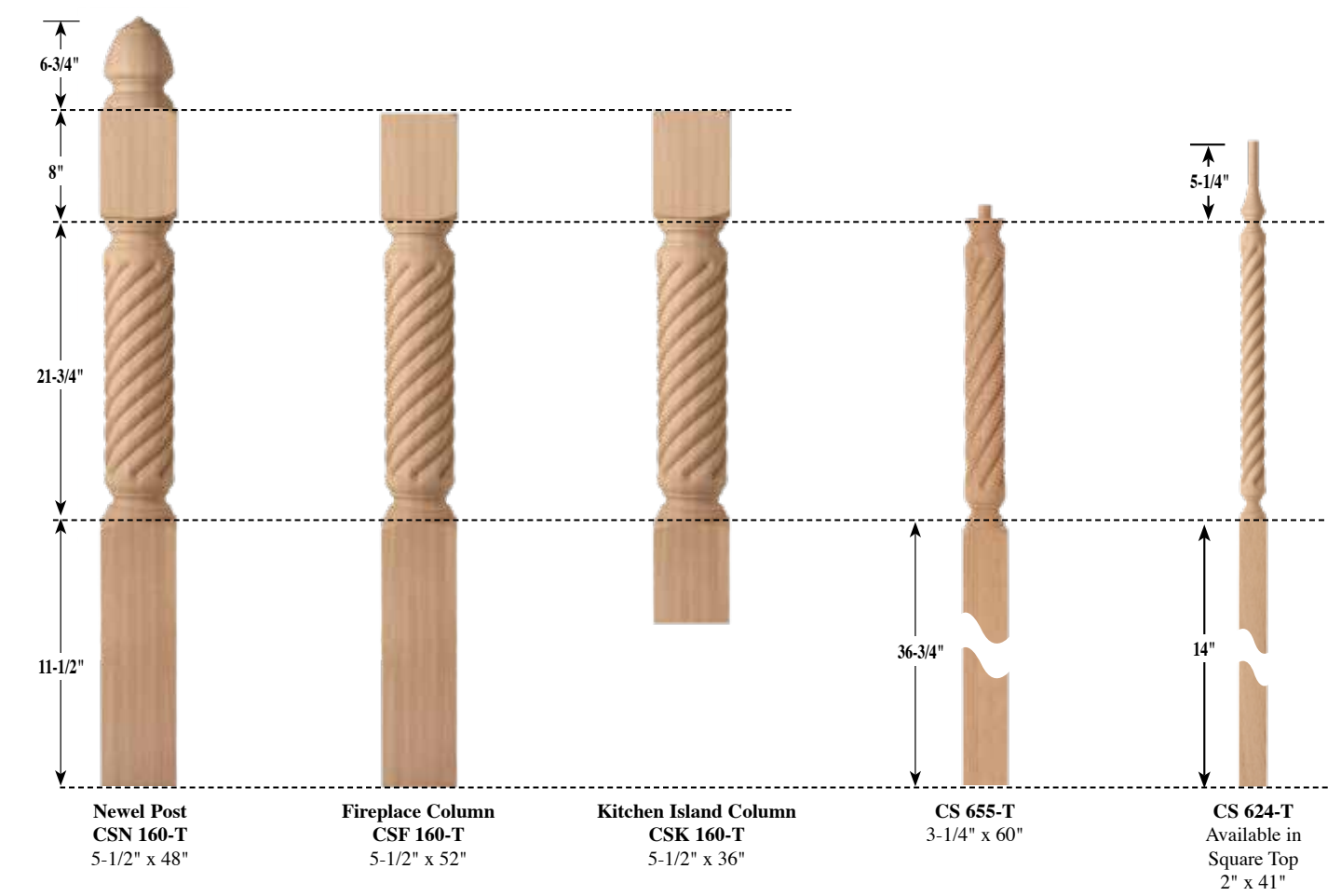

Floridian Series

Custom Profiles

Carrabelle Series

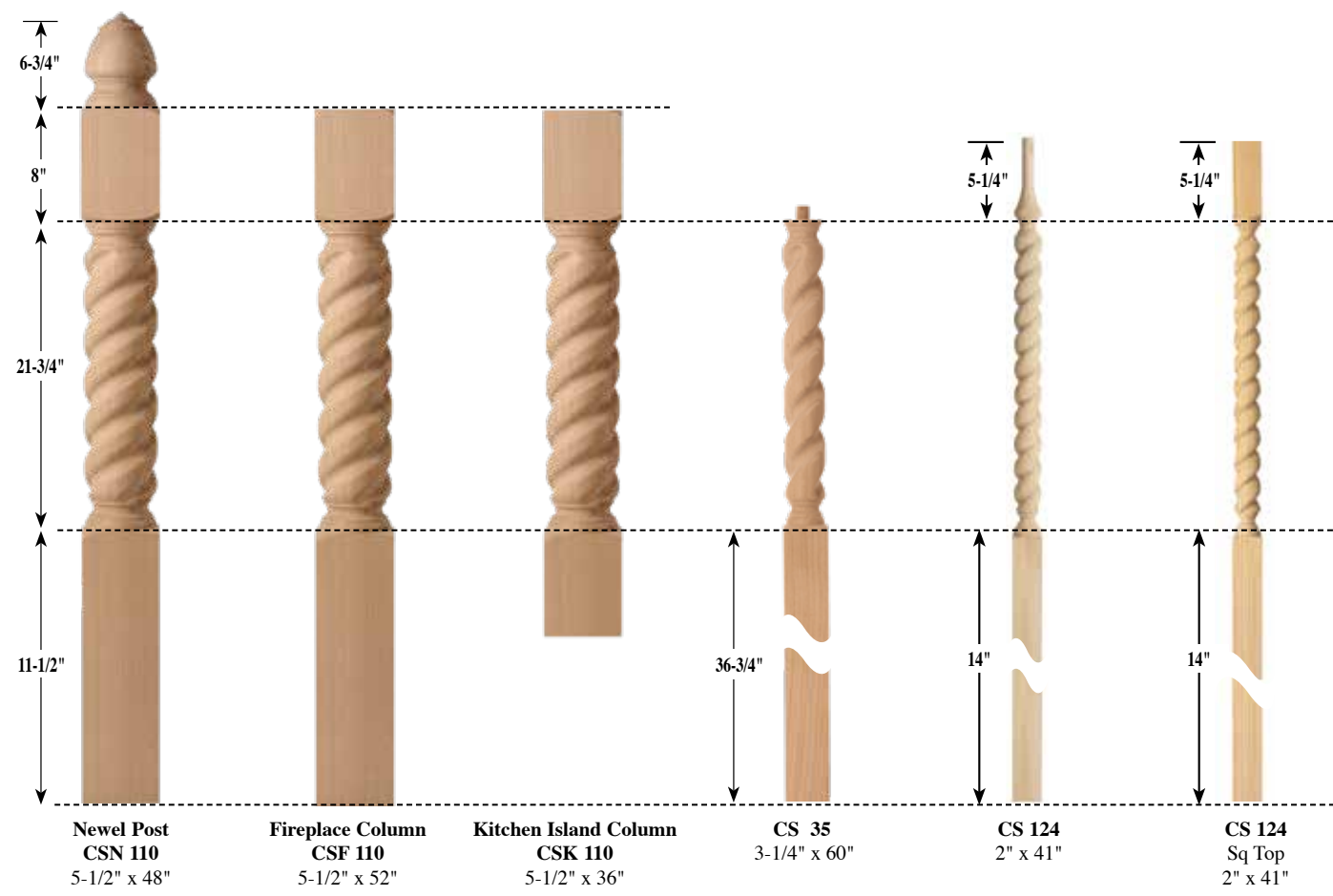

800-364-3269

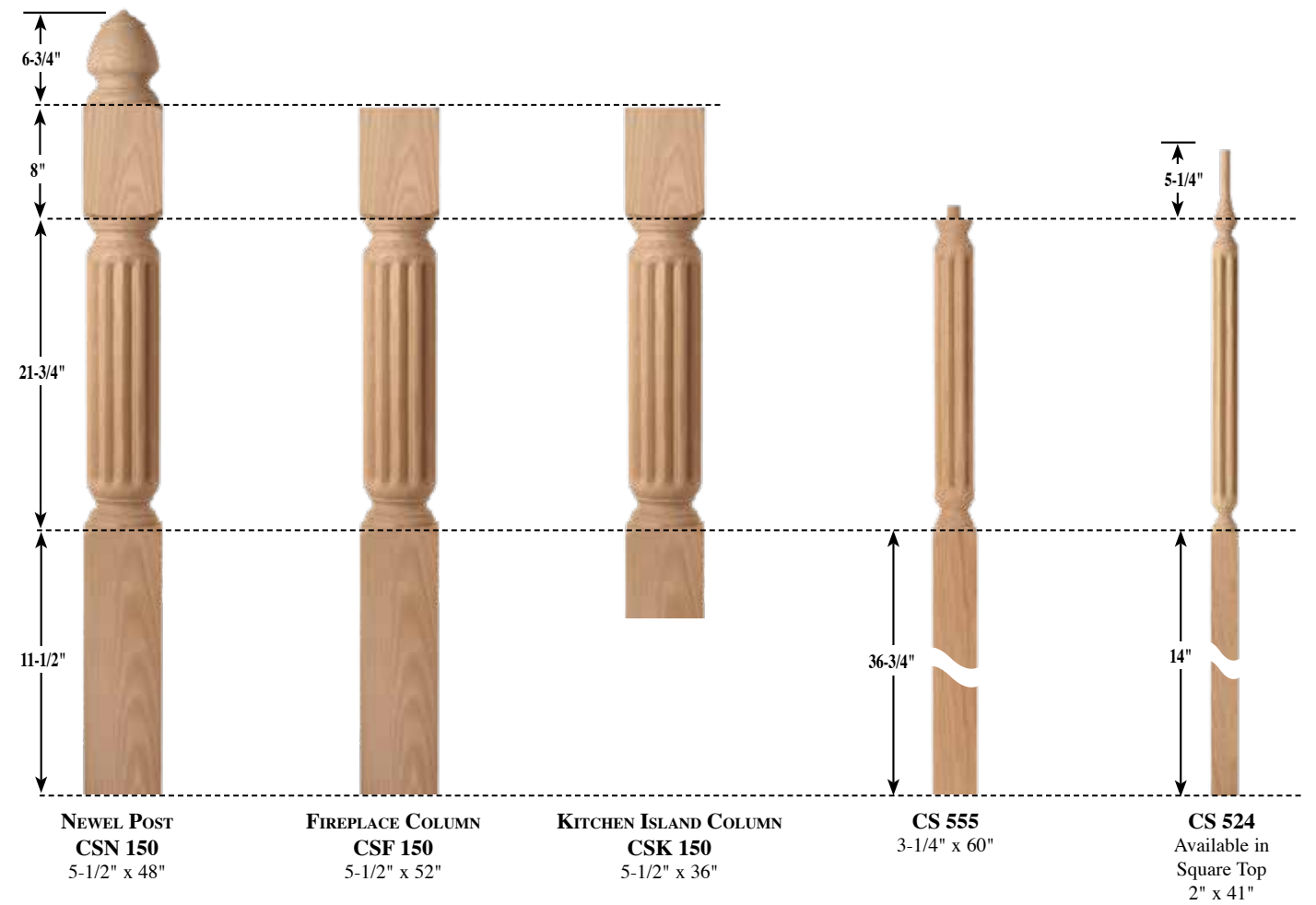

Available in most species

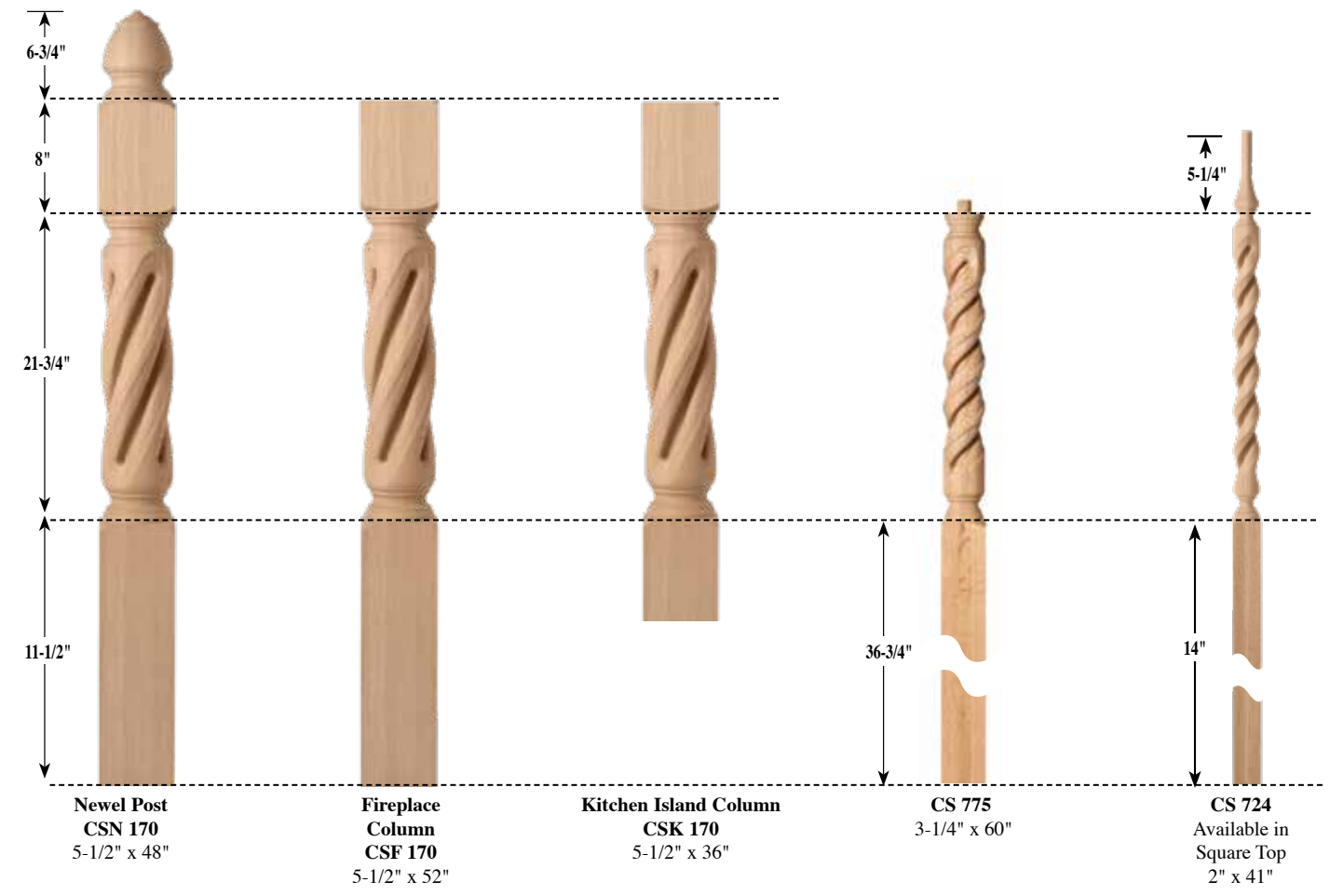
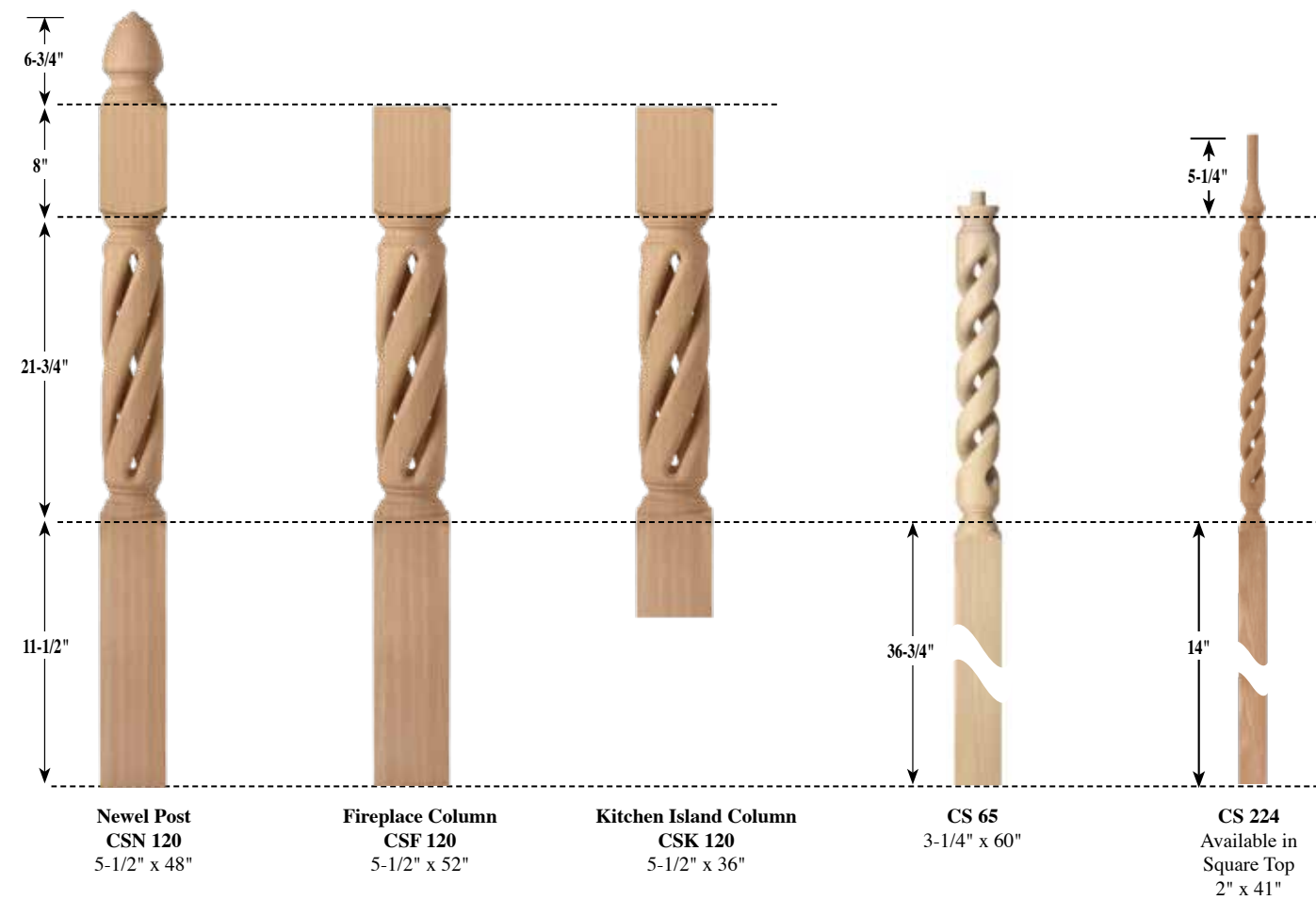

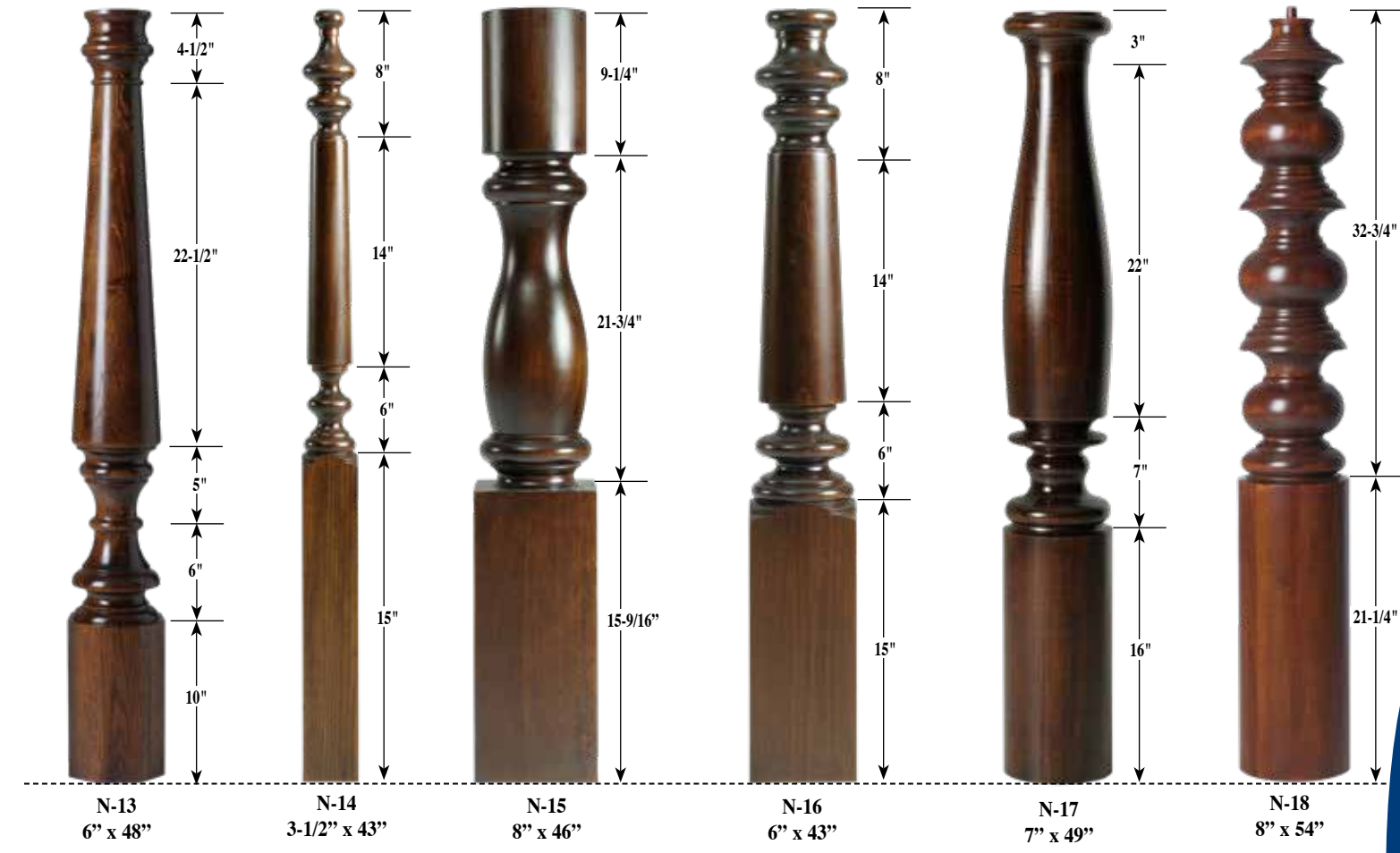
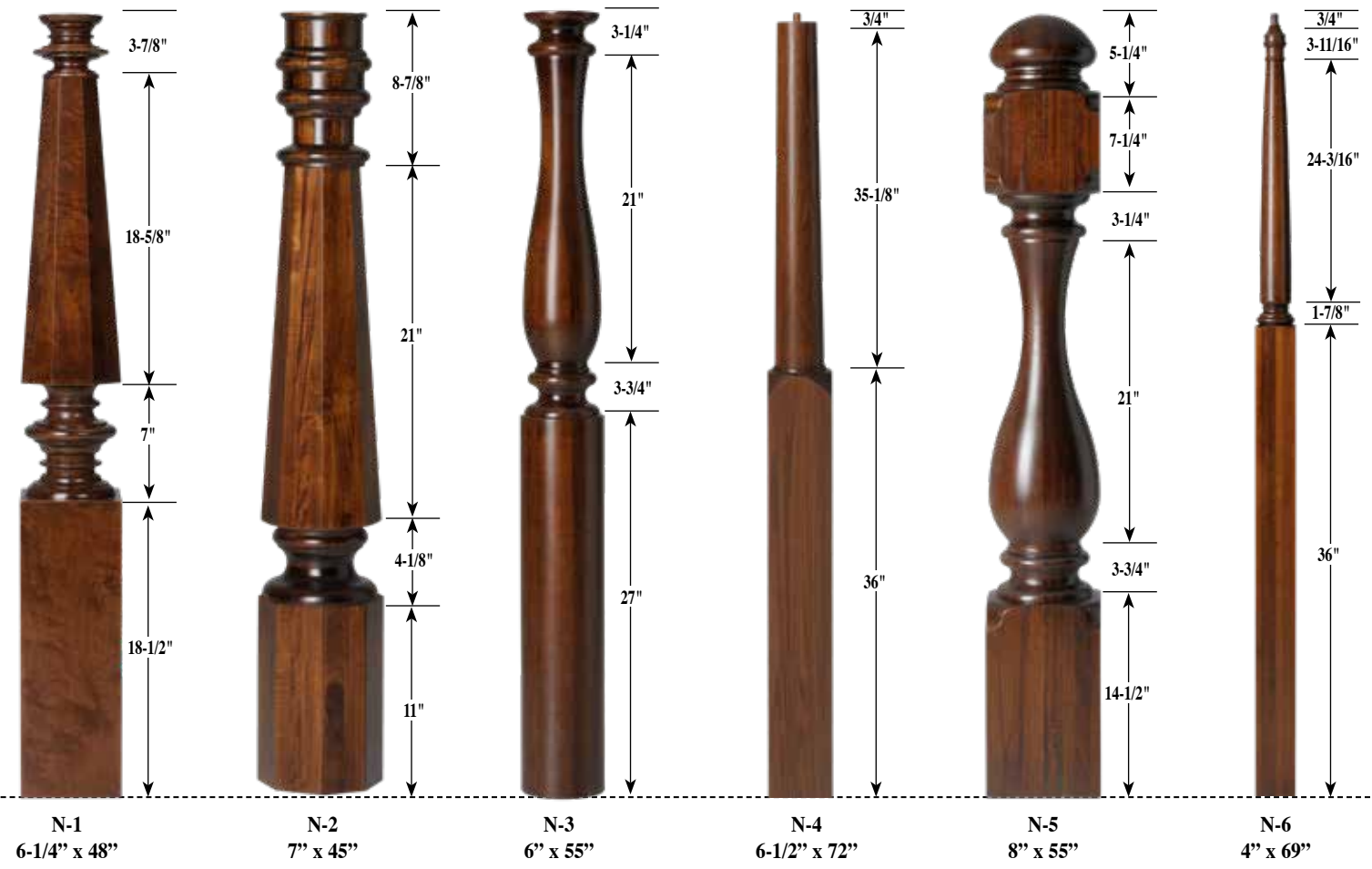

800-364-3269

Available in most species

*All custom newels can be turned in various blank sizes. Changing the size may alter some of the detail.

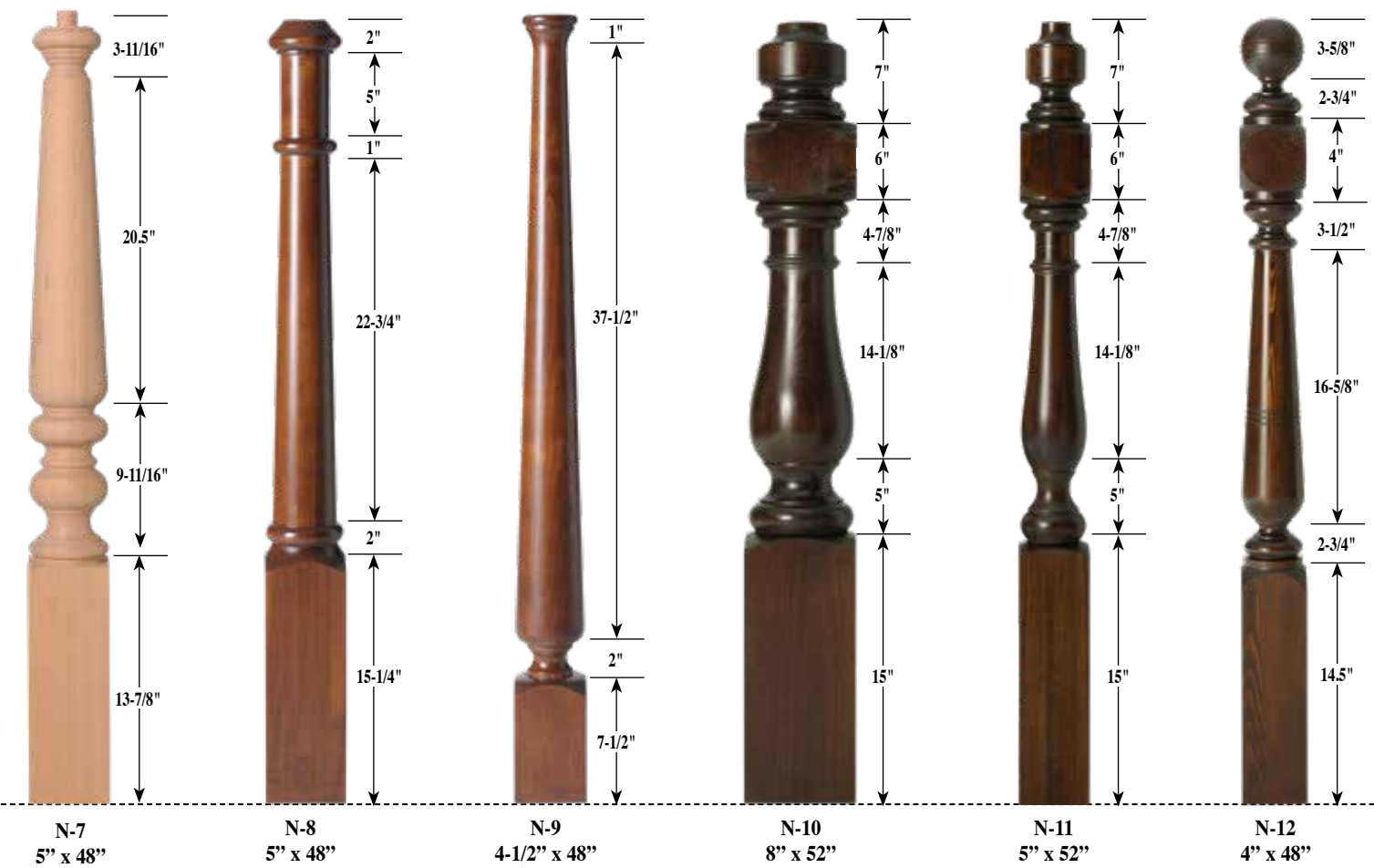

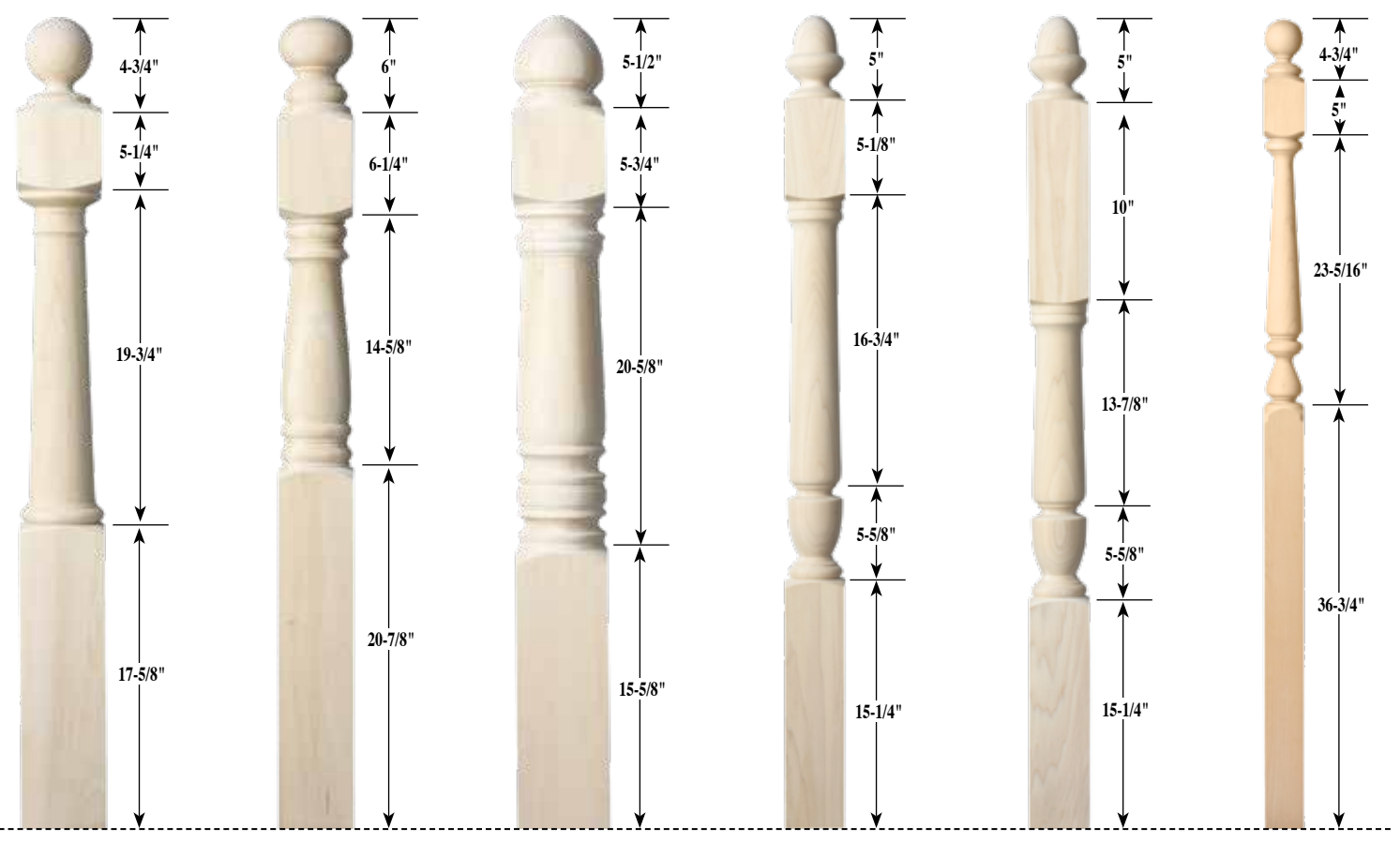

N-25 5" x 48"
 N-26 4-3/8" x 48"
 N-27 5-1/2" x 48"
 N-28 3-1/2" x 48"
 N-29 3-1/2" x 48"
 N-30 3-1/2" x 72"

800-364-3269



N-37 7-1/4" x 33"
 N-38 6-1/4" x 45"
 N-39 5" x 48"
 N-40 8" x 48"
 N-41 5" x 34"
 N-42 5-1/2" x 52"

Available in most species

*All custom newels can be turned in various blank sizes. Changing the size may alter some of the detail.

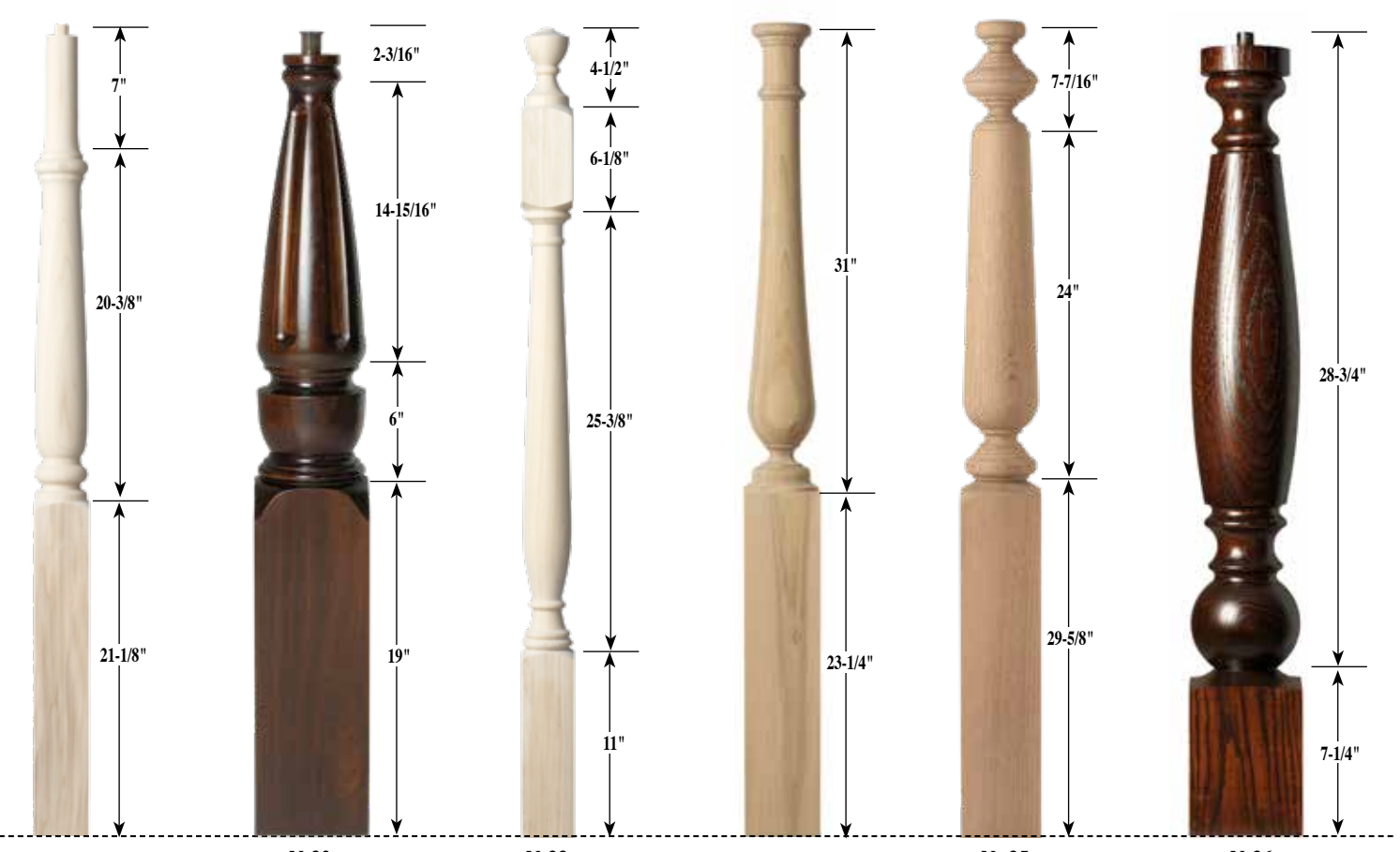

N-31 3-1/4" x 48"
 N-32 6" x 42-1/4"
 N-33 3" x 48"
 N-34 5" x 54"
 N-35 5-1/2" x 60"
 N-36 5" x 37"

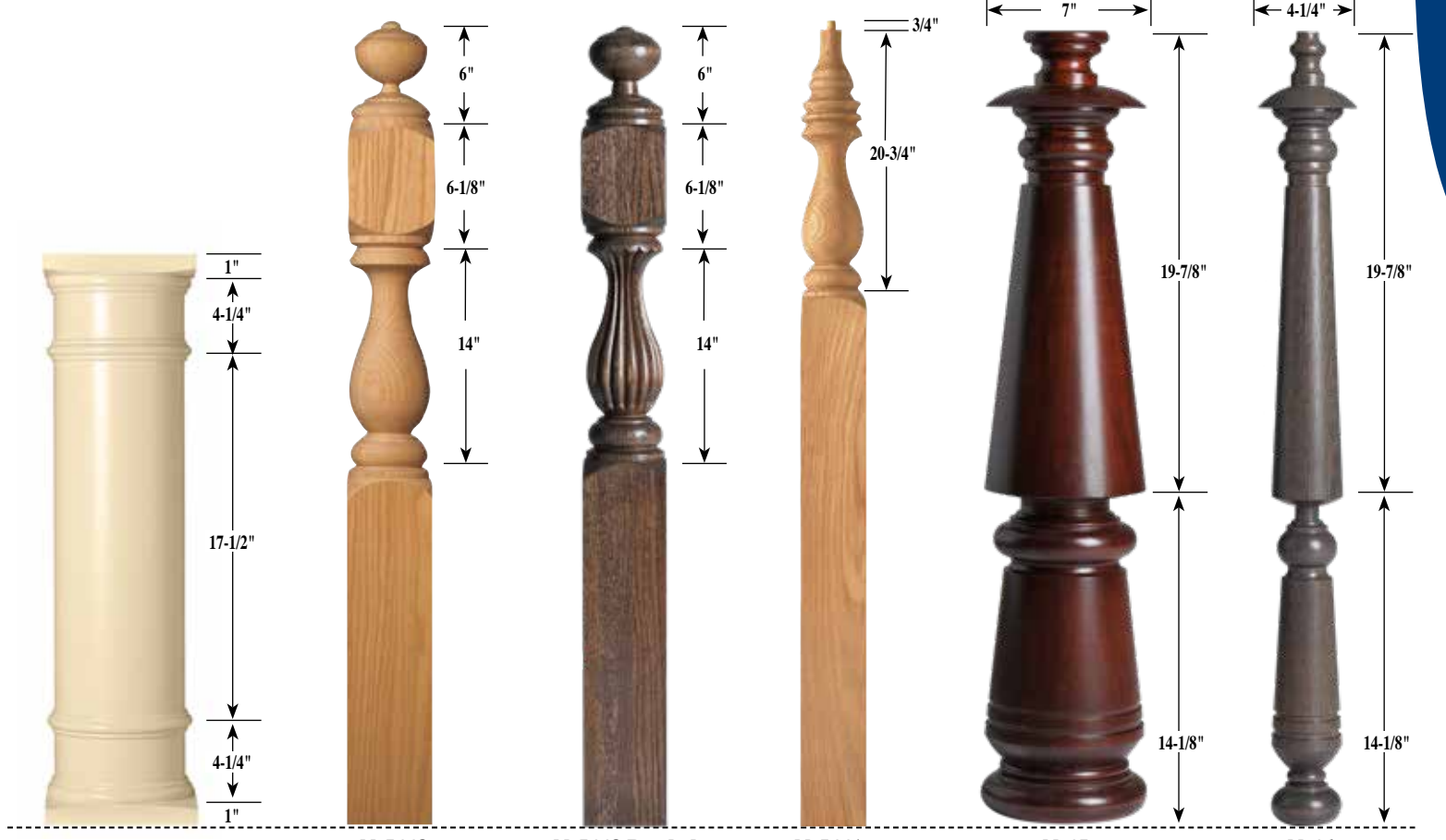

N-43 7-1/2" x 28"
 N-5448 5" x 48"
 5" x 60"
 N-5448 Reeded 5" x 48"
 5" x 60"
 N-5441 5" x 48"
 5" x 60"
 N-45 7-8/25" x 34"
 N-46 4-1/4" x 34"

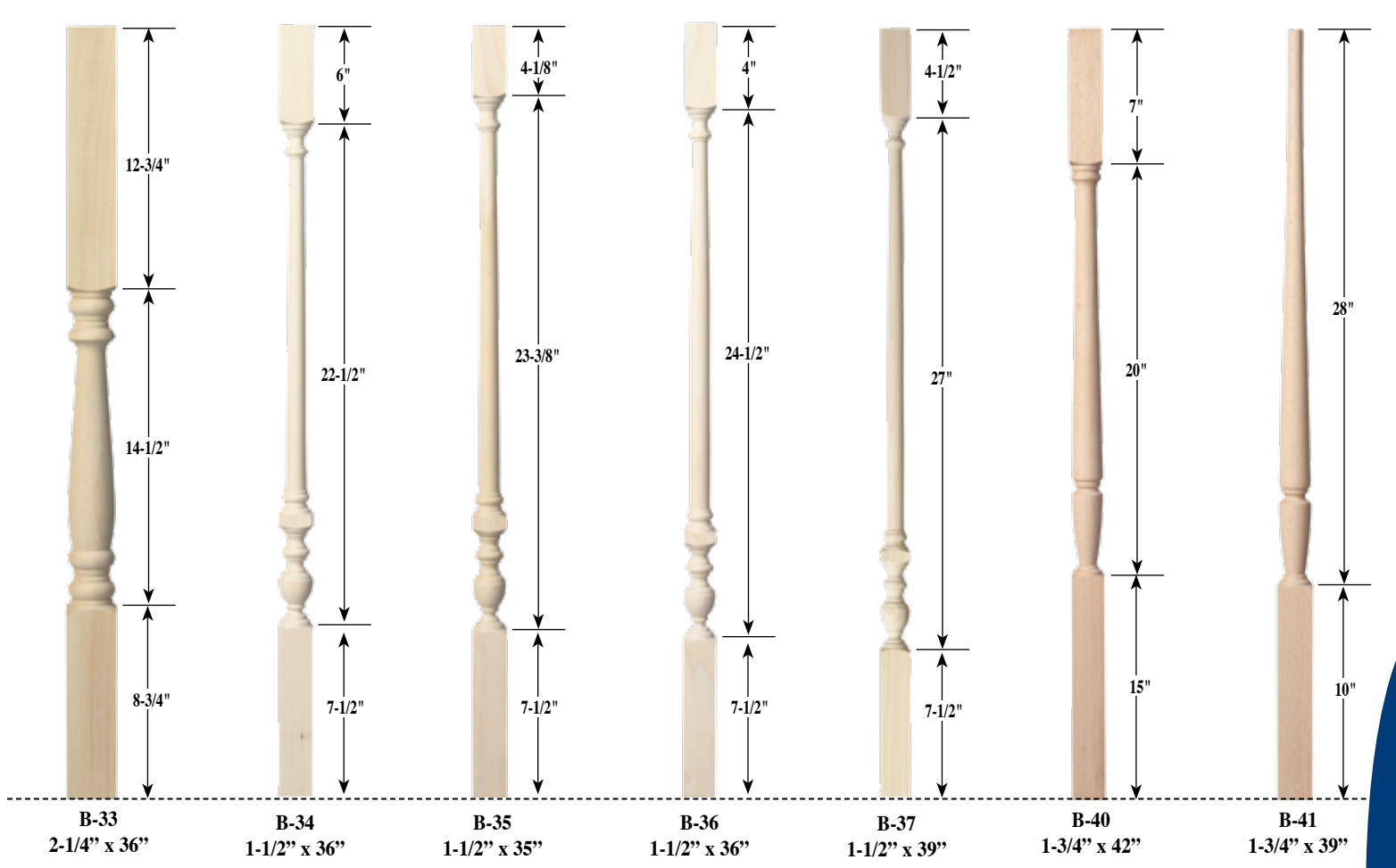
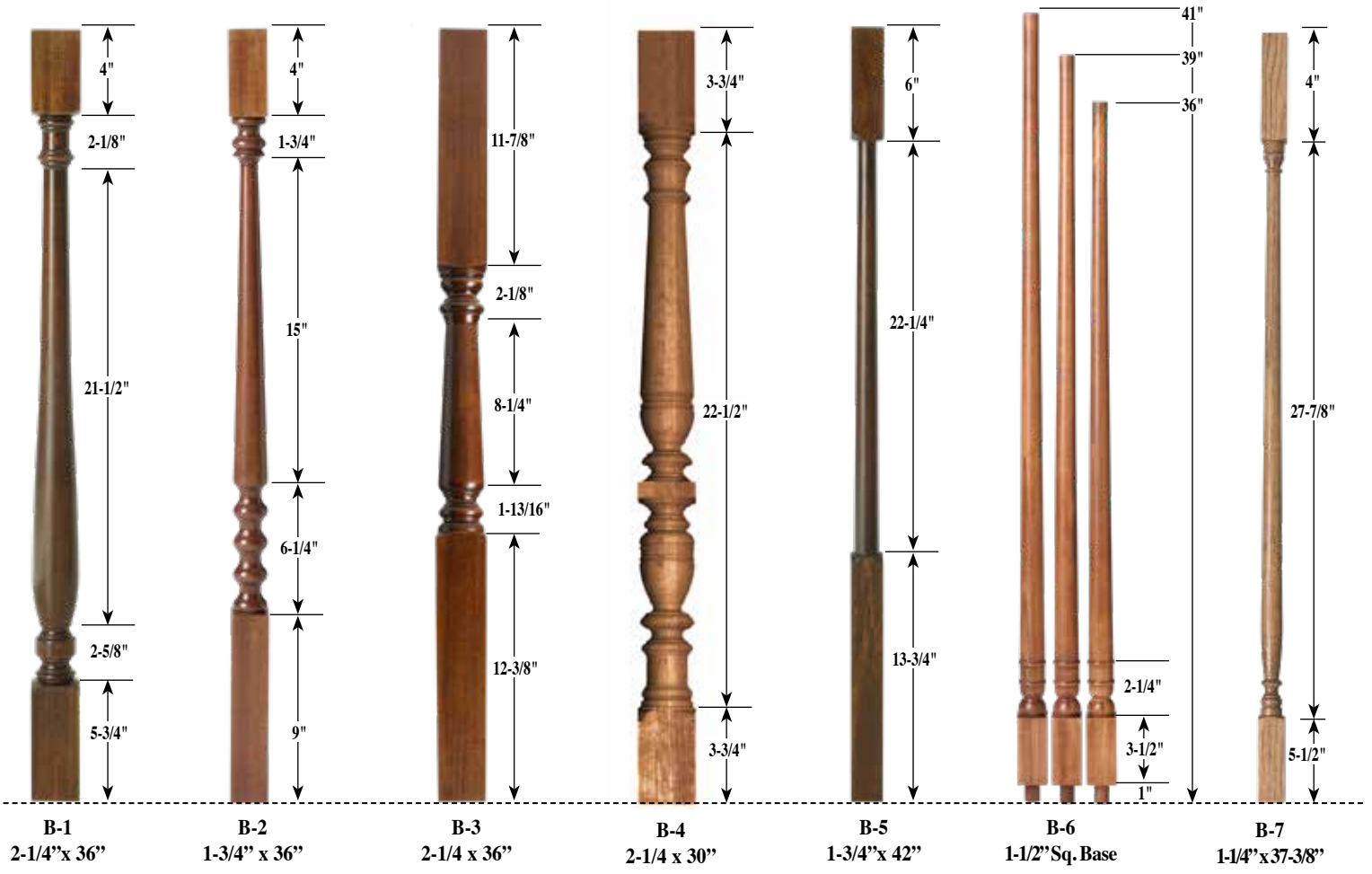

800-364-3269

Available in most species

*All custom newels can be turned in various blank sizes. Changing the size may alter some of the detail.

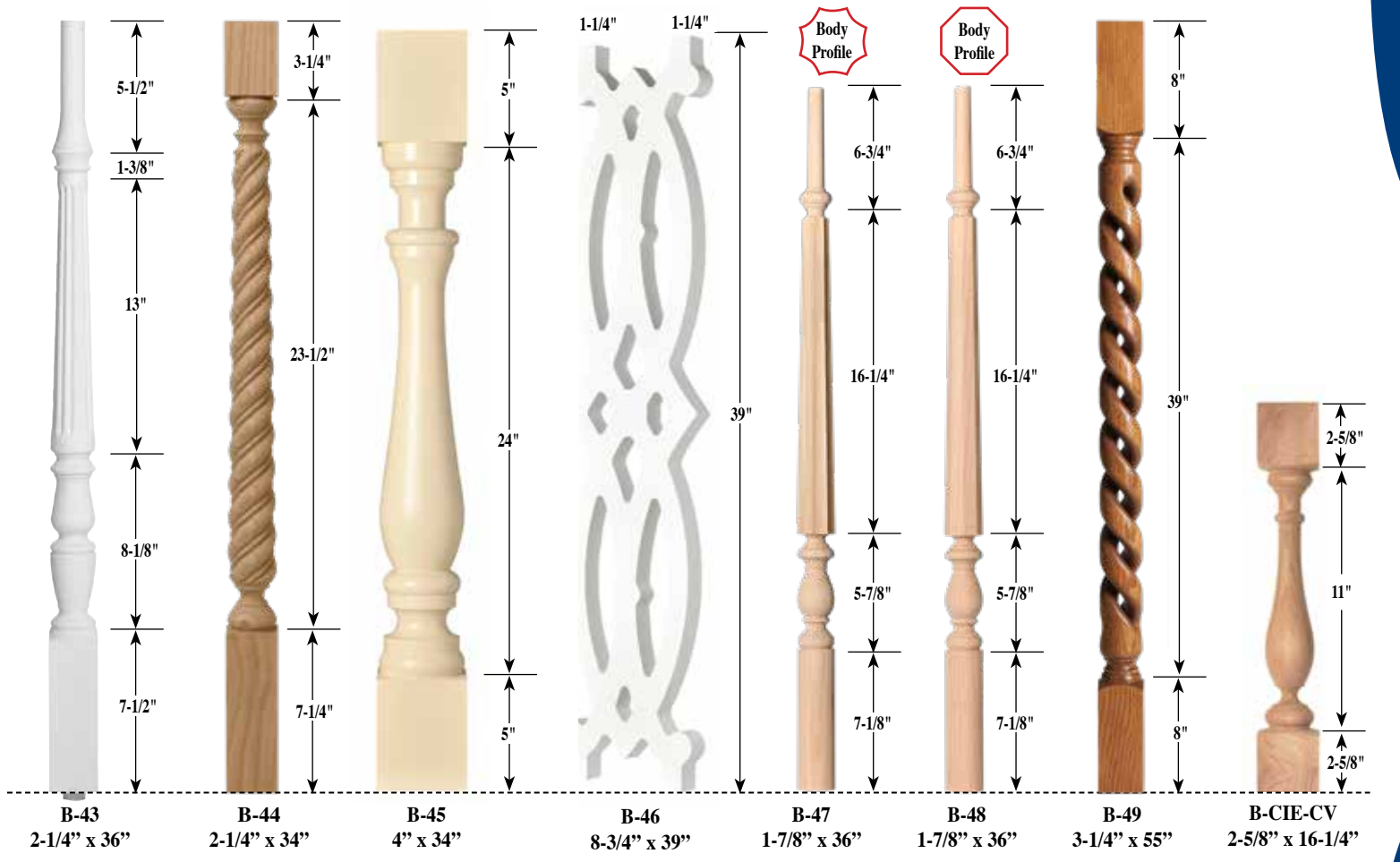
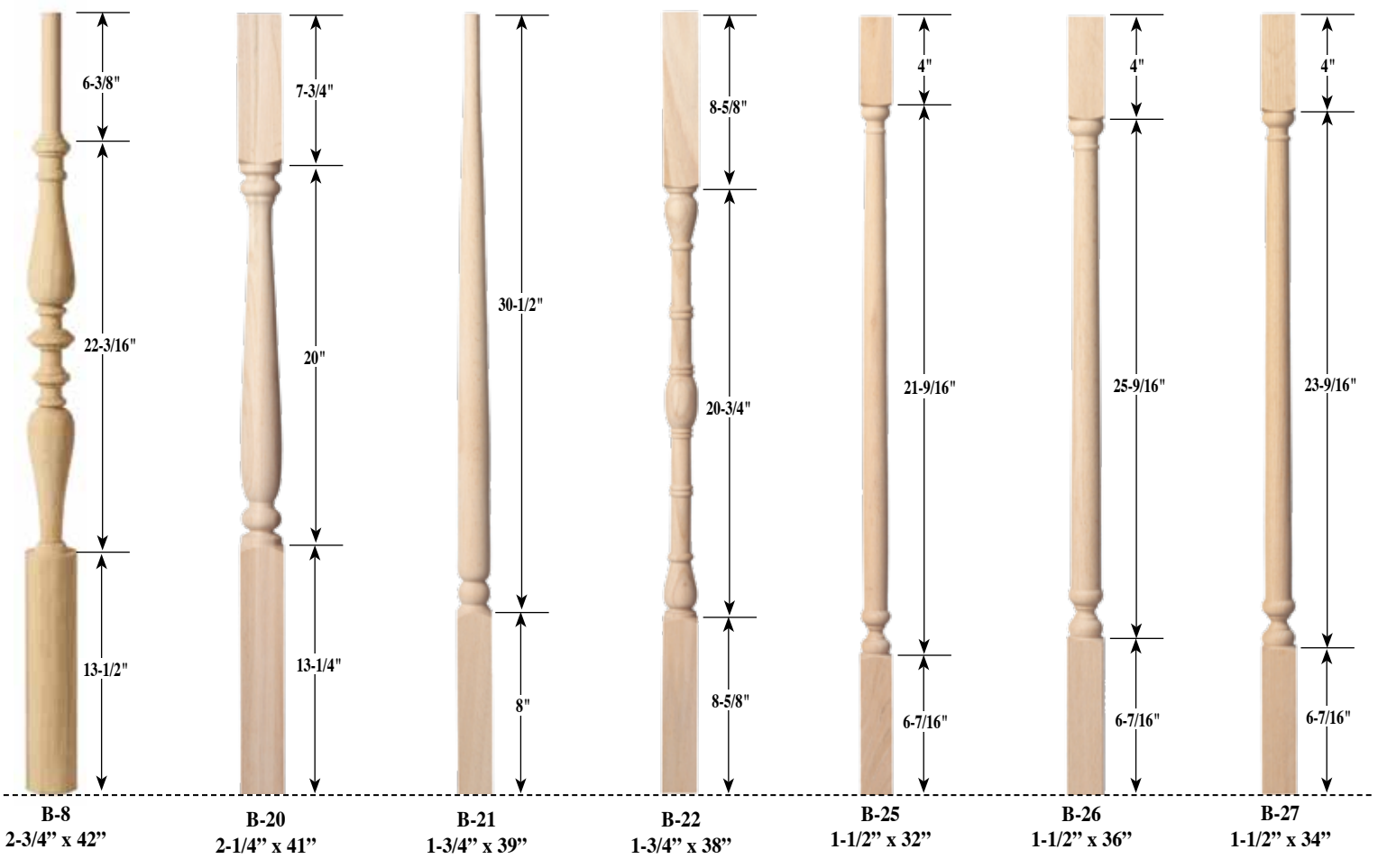



Iron

316 Herrick Street, Uhrichsville, Ohio 44683

Tel: 800-364-3269

Tel: 740-922-3333

Fax: 740-922-3330



Finish Options

The process of powder coating involves applying dry pigments using an electrostatic process, then baking them on to create a lasting and durable, as well as beautiful, finish.

The products found in the following section implement the powder coating technique. When ordering, please use the Finish Options Guide below.

Please indicate the type of finish by using the following abbreviations:

- AN = Antique Nickel
- B = Flat Black Powder Coat
- SP = Grey Speckled Powder Coat
- SAT = Satin Black
- CV = Copper Vein Powder Coat
- ORC = Oil Rubbed Copper
- ORB = Oil Rubbed Bronze

Example: CS 16.5.5-B = Carolina Stair Flat Black Twist & Basket Newel

Finish Options

 AN	 SAT
 SP	 B
 CV	 ORC
 ORB	<i>Iron Chain Color Samples Available Upon Request</i>



800-364-3269

S and T in the available color charts refers if an item is available in solid or tube

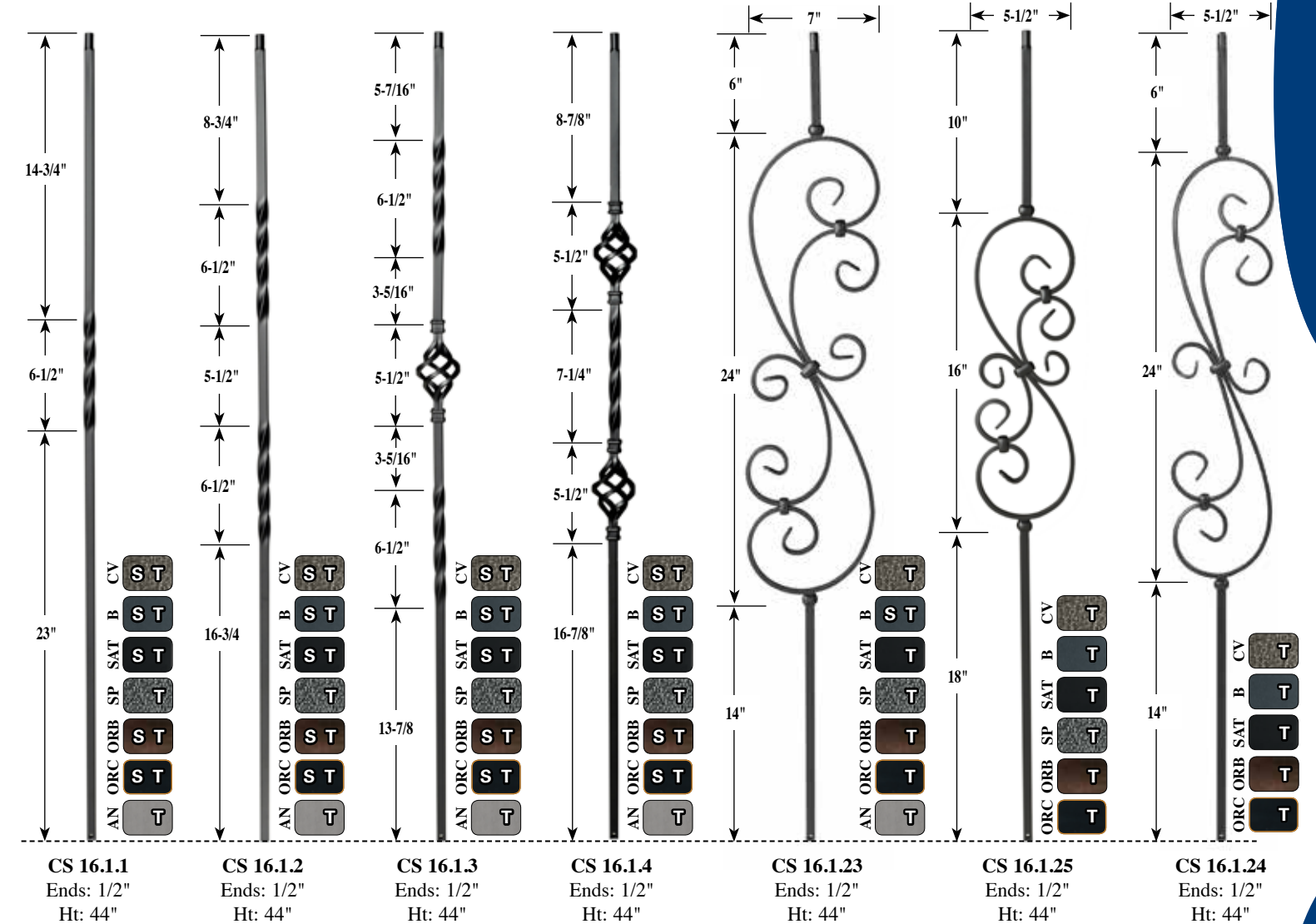

800-364-3269

S and T in the available color charts refers if an item is available in solid or tube

Tapered & Hammered

Ribbon Twist

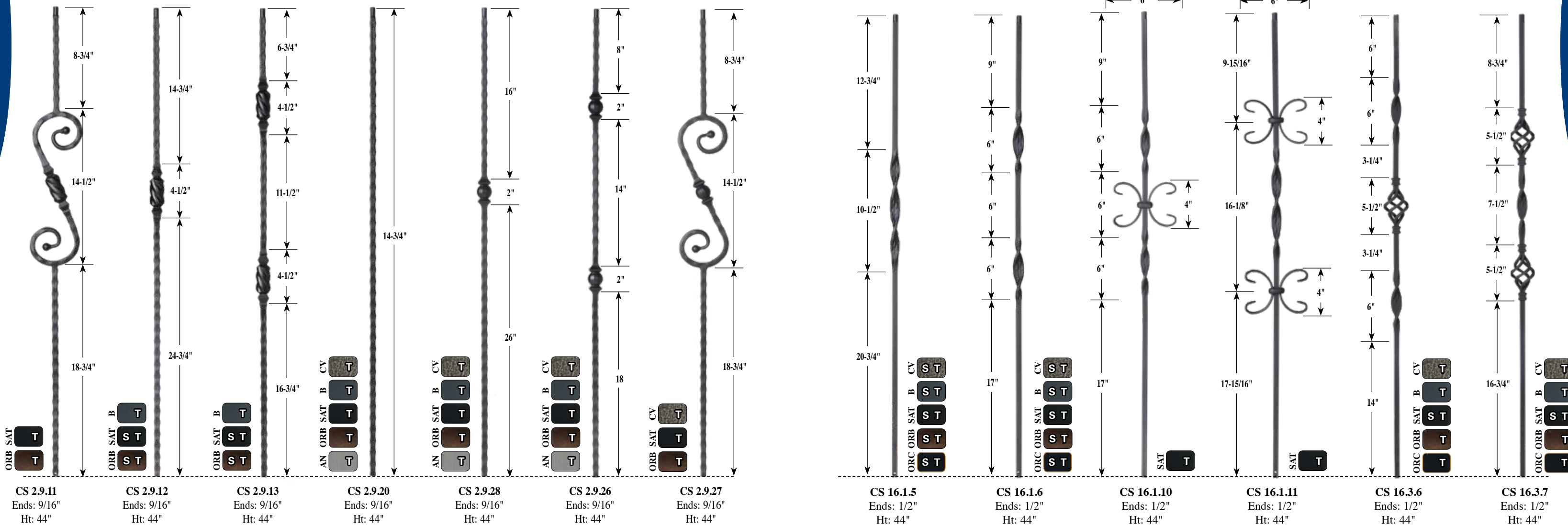



800-364-3269

S and T in the available color charts refers if an item is available in solid or tube

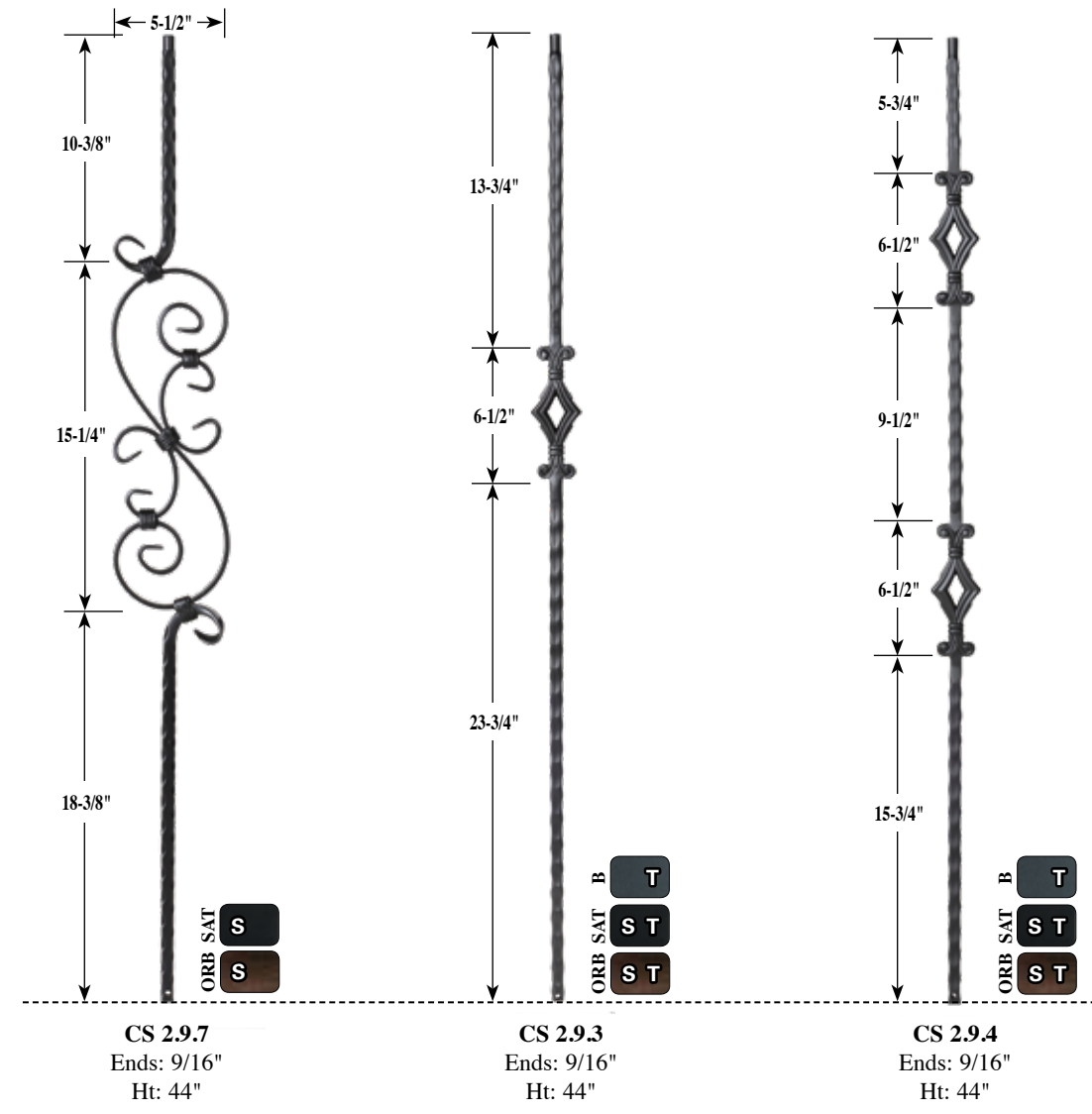
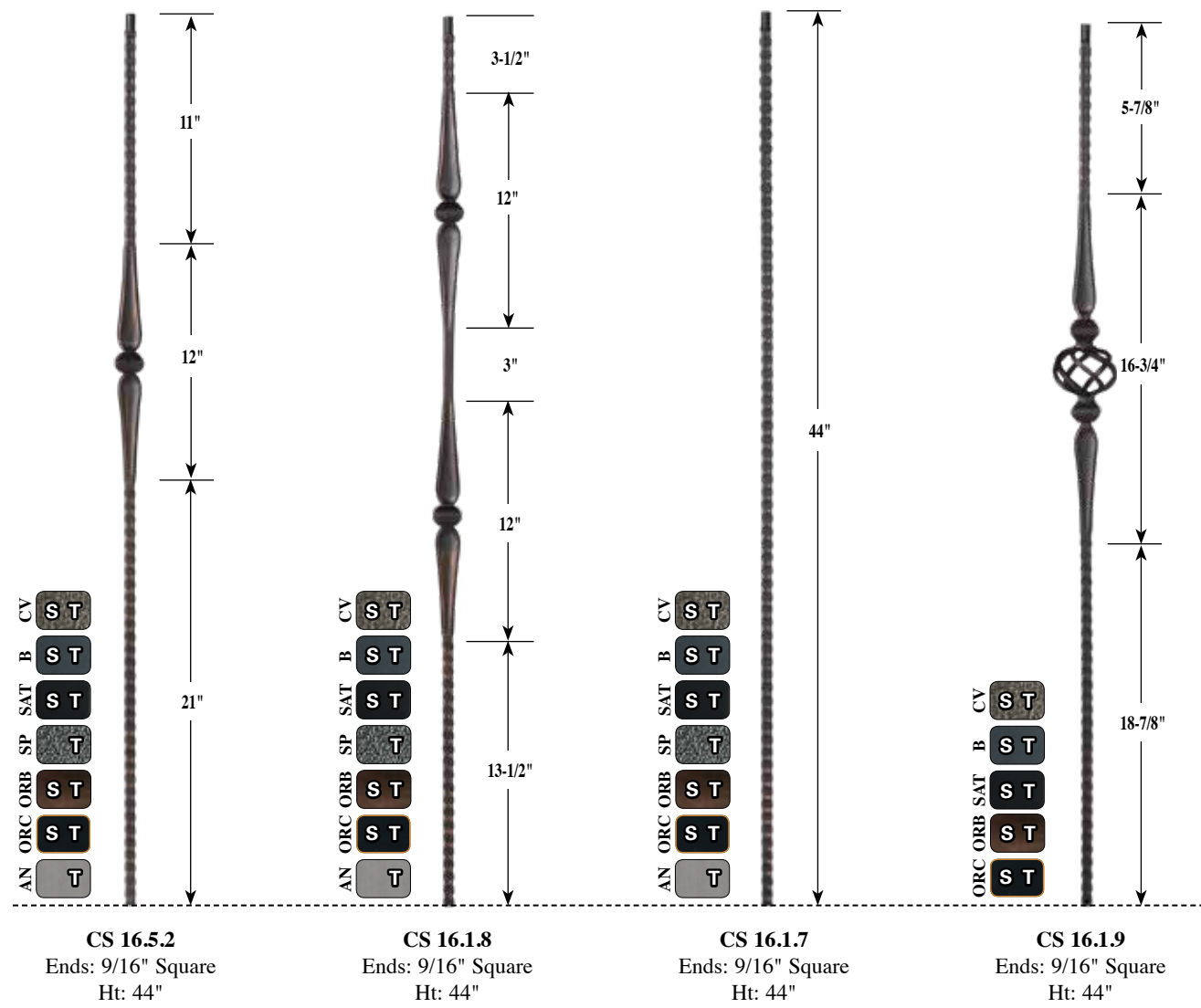



Iron Balusters

Knee Wall Balusters

800-364-3269

S and T in the available color charts refers if an item is available in solid or tube

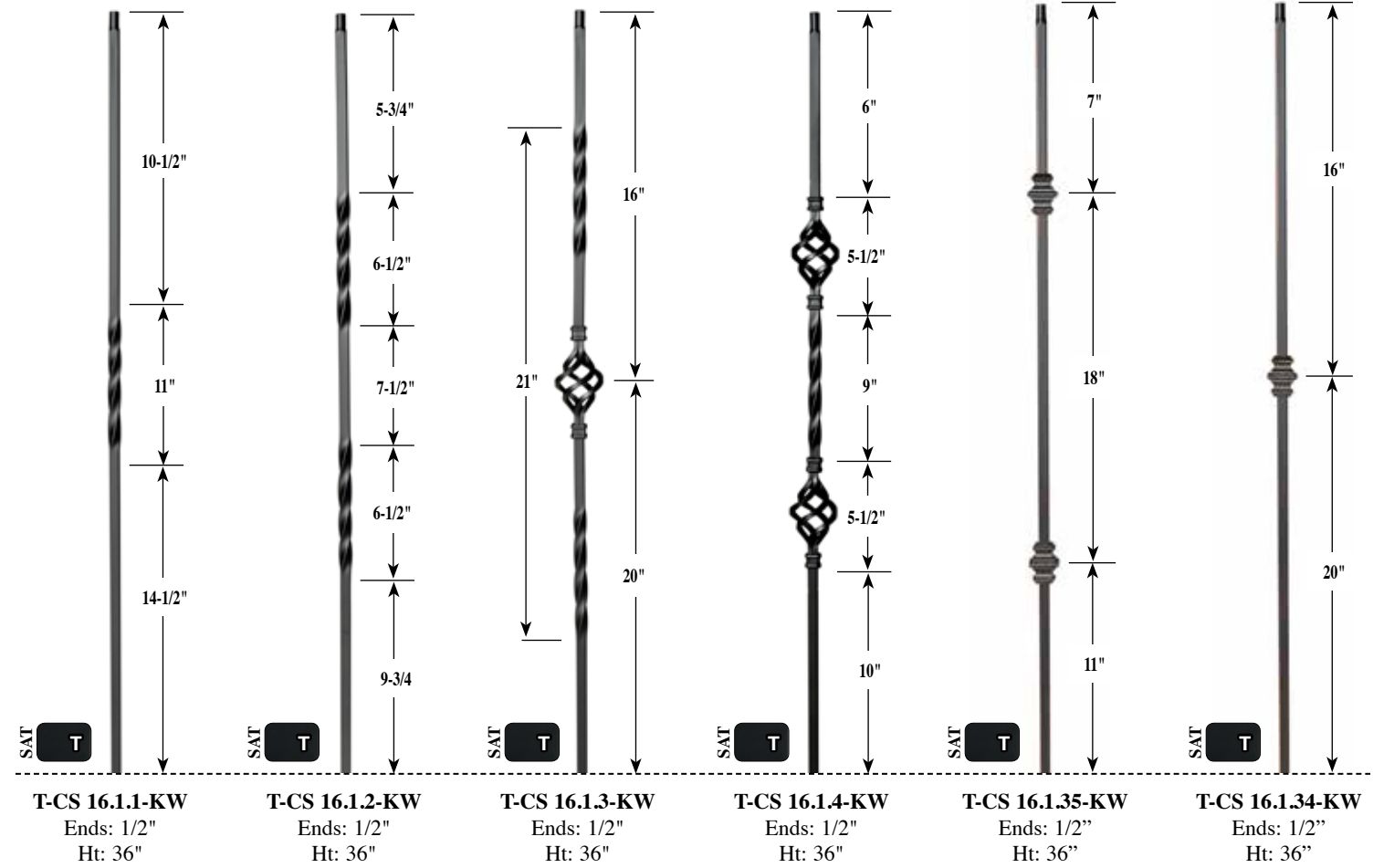
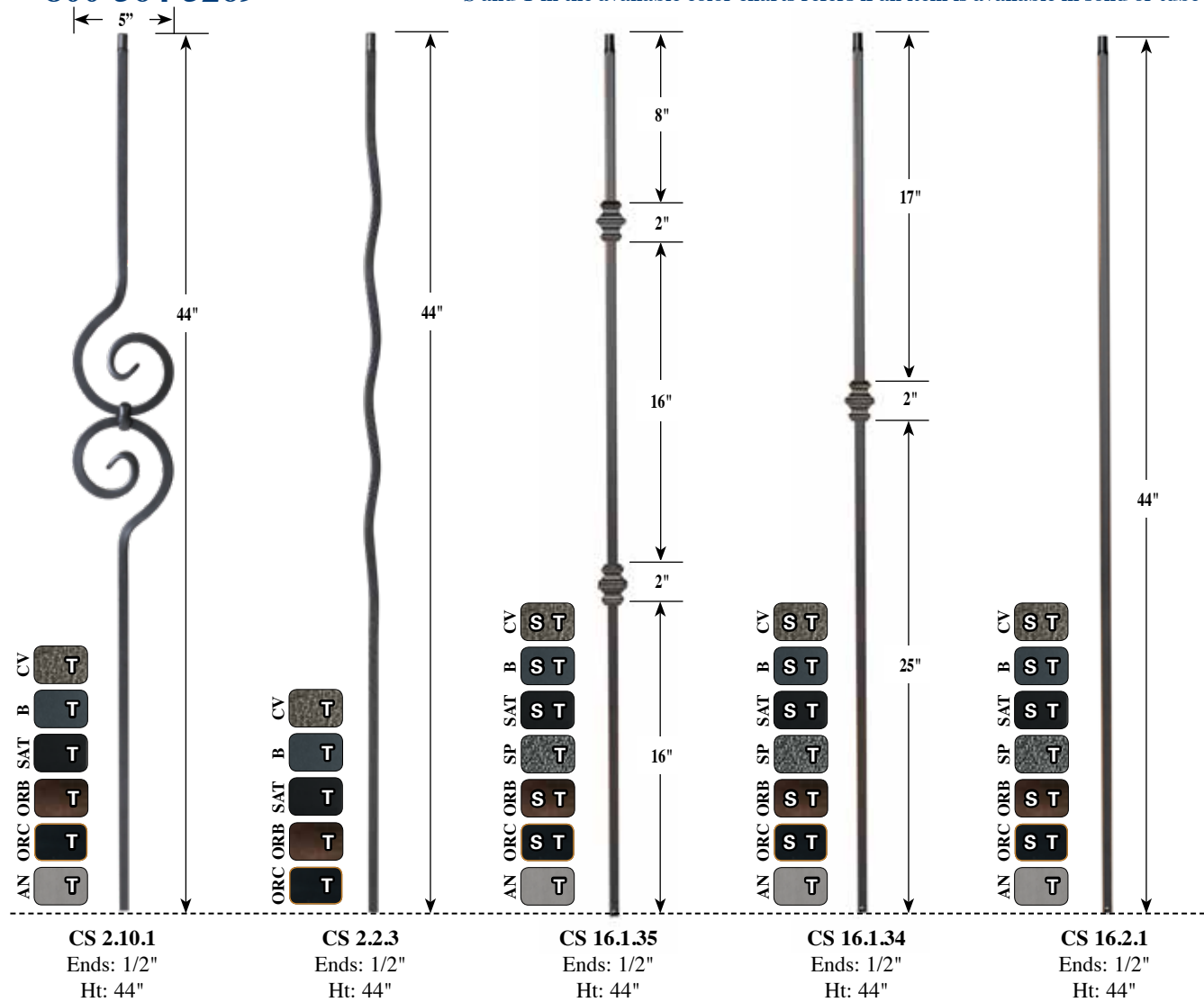

Wave & Curl Forged

Regular Twist and Knuckle



800-364-3269

S and T in the available color charts refers if an item is available in solid or tube

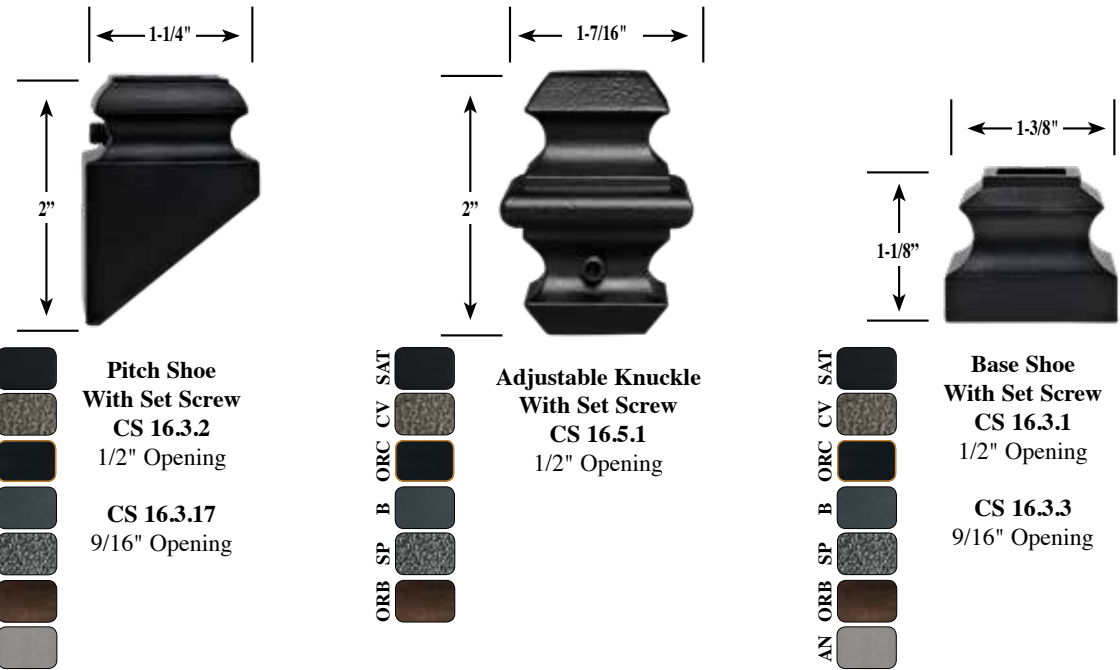
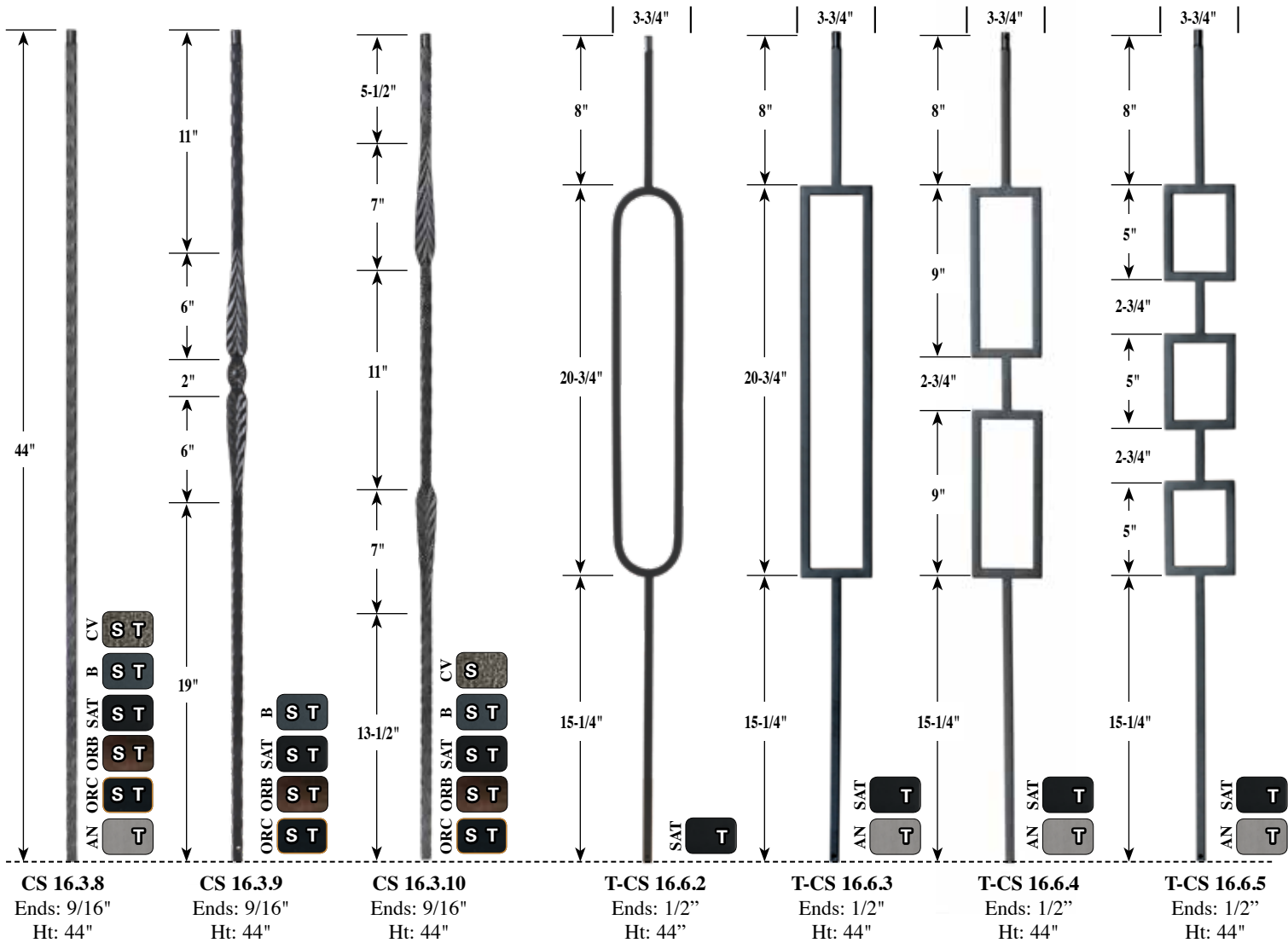

Epoxy Kit

800-364-3269

S and T in the available color charts refers if an item is available in solid or tube



Zip Clip Installation

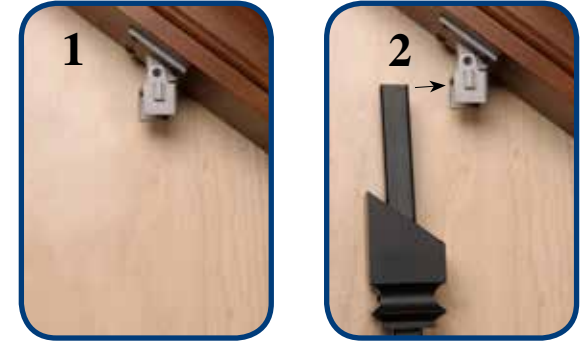

1 Install Clip To Handrail and Tread

2 Slide Iron Baluster In Place With Shoes Installed



Zip Clip Shoe Dimensions
 Flat Shoe = L 1-7/16" x W 1-7/16" x H 1-1/4"
 Pitch Shoe = L 1-1/4" x W 1-1/4" x H 2-1/2"

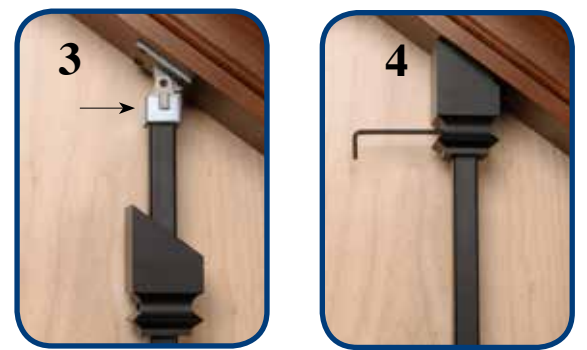

3 Snap Retaining Clip In Place

4 Slide Shoe In Place And Tighten



Custom Box Newel by CSS • Baluster: CSPLA • Rail: R15 • Fittings: Oversize R15-10 Cap

Custom Box Newel by CSS • Horizontal Bar: T-CS 5.1.1-SAT • Rail: 8700 • Tread: 8075

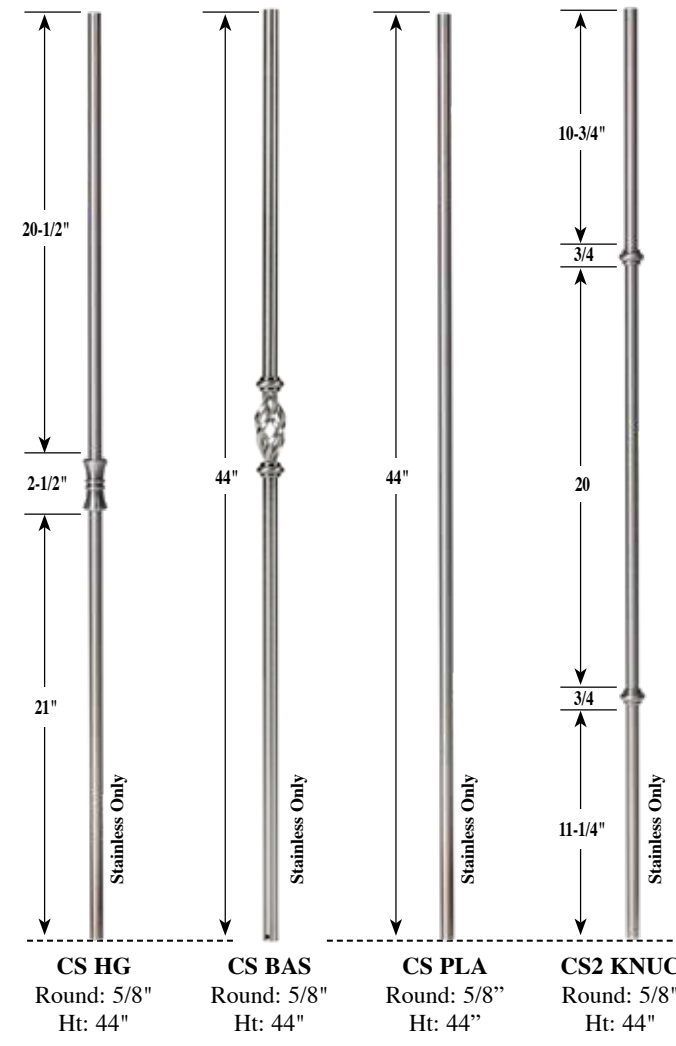

Iron Balusters

Fusion & Horizontal Bar

Ole' Iron Slides™

With the advent of the adjustable iron slide baluster, the do it yourself person can now design and install their own balustrade. Using only a drill, screwdriver and an allen wrench, the adjustable iron baluster can replace your old wood spindles without the expense of a professional. Leave your wood rail and newels in place, remove the wood spindles and replace them with a wrought iron balustrade quickly and without a big mess. Presto, you have a new design flavor for your living area.

Allen Wrenches Required: 4mm & 2mm

Ole Iron Slides™ is a trademarked and patented adjustable baluster owned by Carolina Stair Supply Inc.

Scan this code to watch the video

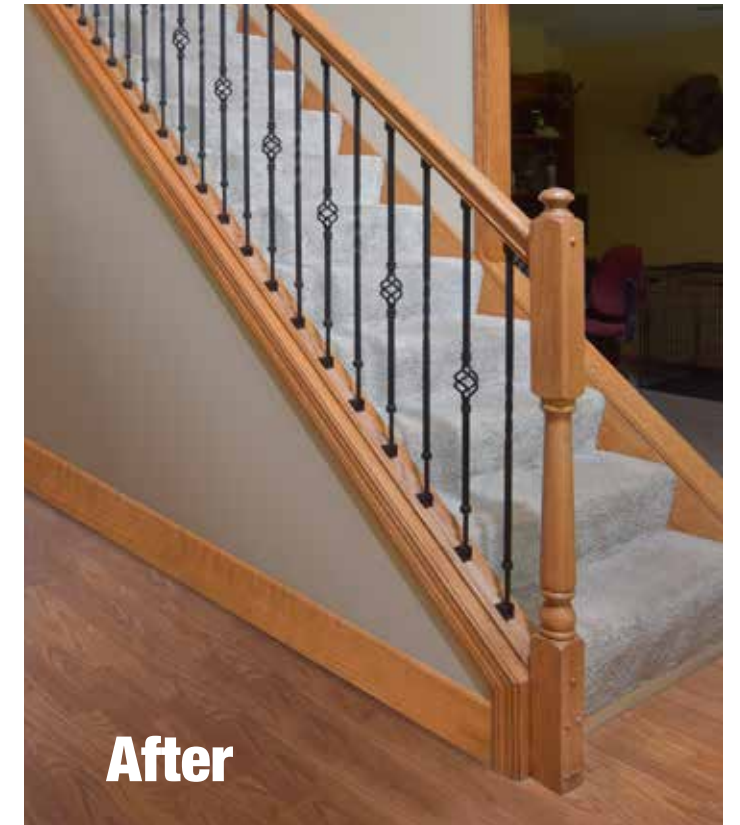

Patent No.:
 7,614,612 B2 7,909,311 B2 D610,716 S D637,315 S
 8,418,335 B2 D614,477 S 8,978,337 B2

Each baluster comes with loose ISSW in the package.

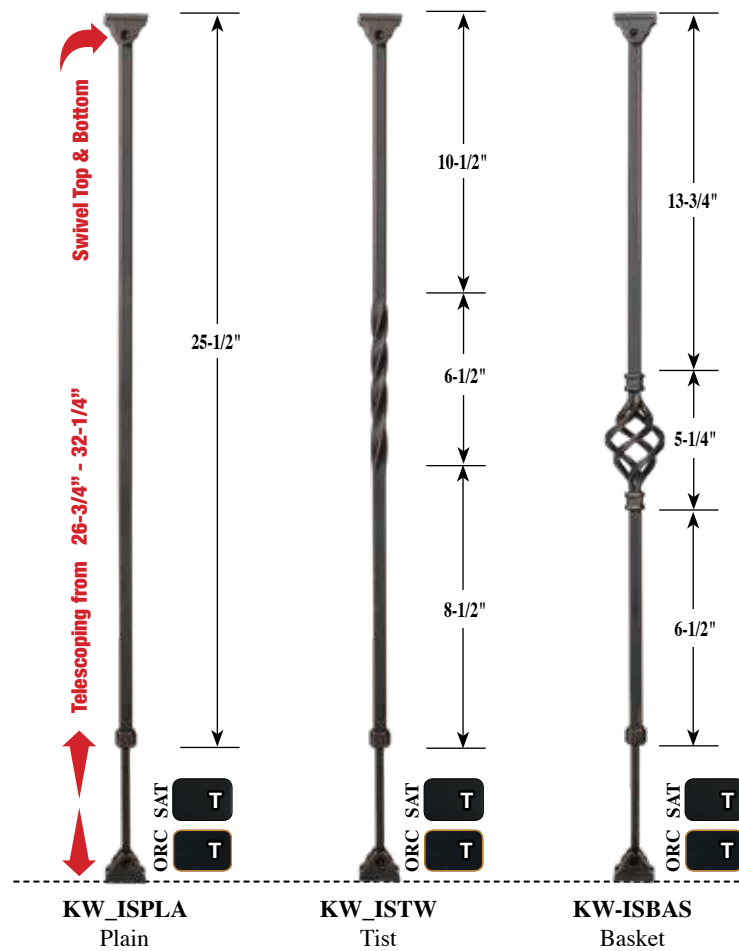
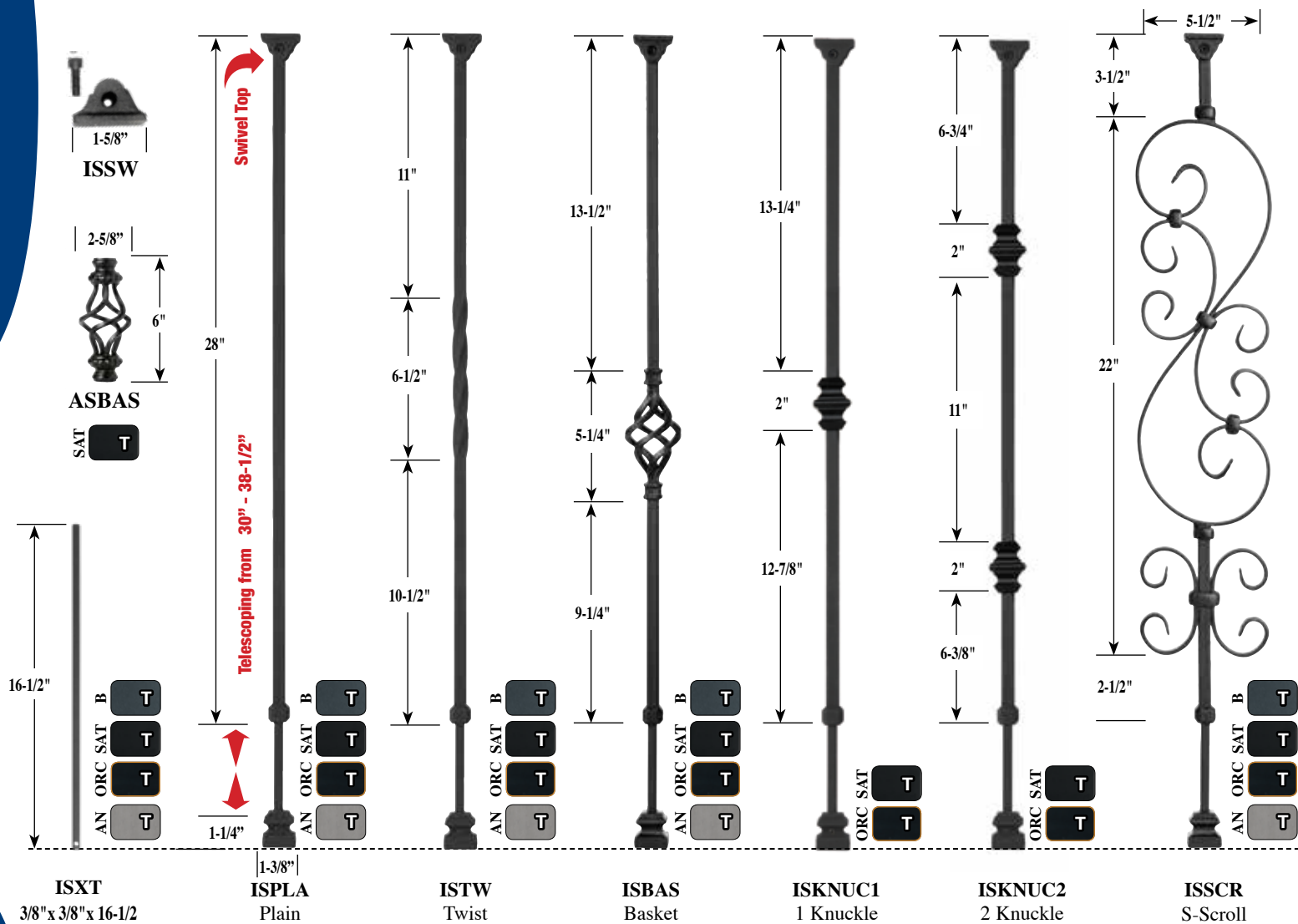

**Also Available in Outdoor Aluminum Balusters
 Telescoping from 34" - 42"**

MISTW-EXT-SAT
 Ends: 5/8" Aluminum
 Twist

MISBAS-EXT-SAT
 Ends: 5/8" Aluminum
 Basket



Telescopes
 26-3/4" - 32-1/4"

Ole Iron Slides™

Ole Iron Slides™

Ole Iron Slides™ Knee Wall

Accessories



1010
Flush Plug 1"



1020
Rail Bolt



1030
Wall Bracket



1032-HD
Wall Bracket

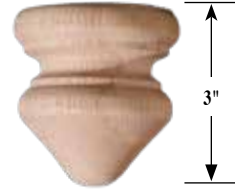

1070
Drop Cap
Available in 3" and 3-1/2" diameter

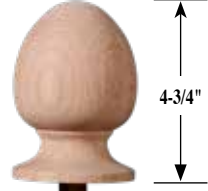

1075
Newel Finial

Items 1030 & 1032 available in the following finishes:
Bright Brass • Antique Brass • Dull Chrome • Satin Nickel
Satin Black • Oil Rubbed Bronze • Oil Rubbed Copper



1060 Oval Rosette
5-1/2"H x 4-1/4"W
1064 Oval Rosette
6-1/2"H x 4-1/2"W



1063 Rectangle Rosette
6"H x 4-5/8"W



1062
Round Rosette
4-3/8" Round

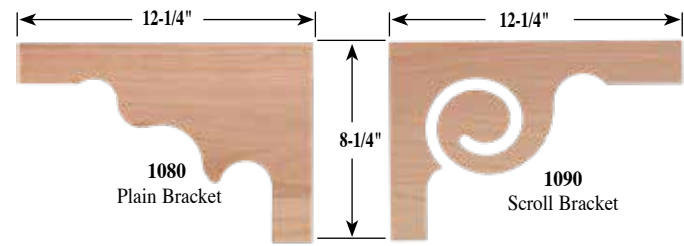

1080
Plain Bracket

1090
Scroll Bracket

1/4" Thick



1103
Newel Anchor



1104
Newel Anchors
3" & 3-1/2" Sizes Available



1106
Spin Driver
(to be used with Dowel Lockscrews)



1107
Dowel Lockscrews
(24 per pack)

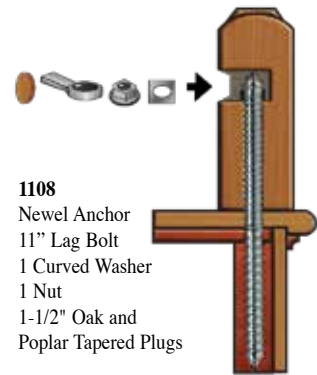

1108
Newel Anchor
11" Lag Bolt
1 Curved Washer
1 Nut
1-1/2" Oak and Poplar Tapered Plugs

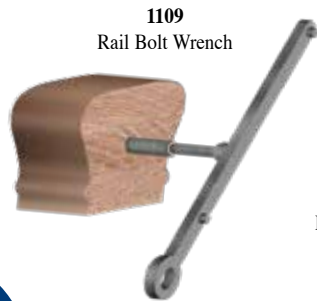

1109
Rail Bolt Wrench



2000
Key Lock



3004
Newel Anchor



3006
Newel Anchor



3007
Hardware Combination Kit





CAROLINA

316 Herrick Street, Uhrichsville, Ohio 44683

Tel: **800-364-3269**

Tel: **740-922-3333**

Fax: **740-922-3330**

