



**MOULDINGS | STAIR PARTS | BOARDS | EXTERIOR MILLWORK**  
**GREAT LAKES DISTRIBUTION CENTER**

# our STORY

## DEEP ROOTS. HIGH STANDARDS. BRIGHT FUTURE.

Founded in 1946 Empire has grown into one of the largest millwork distribution and manufacturing companies in the United States.

With a geographic footprint that touches the majority of the eastern half of the United States, Empire is positioned for continued expansion.

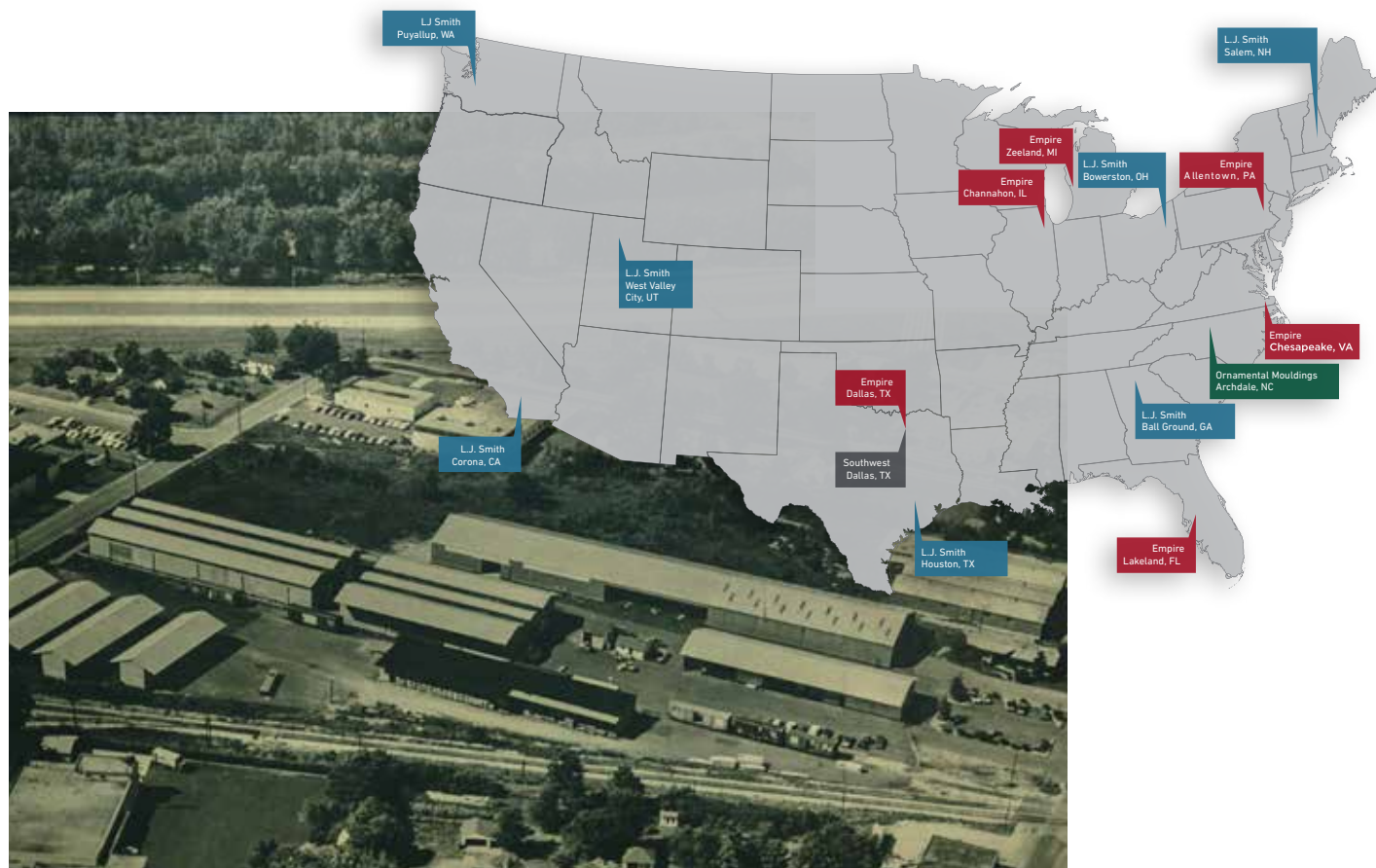

# our FAMILY

## EMPIRE IS NOW A PART OF THE NOVO FAMILY.

Novo Building Products is the industry leading manufacturer and distributor of mouldings, stair parts, doors, and specialty building products. We are proud to serve building material dealers (lumberyards),

door shops, retail home centers, and millwork manufacturing partners throughout the United States and parts of Canada and Mexico.

Learn more at [novobp.com](http://novobp.com).



# TABLE OF CONTENTS

INSPIRATION.....	6-13	COVE   BED .....	36
BOARDS .....	14-16	CROWN.....	36-39
WAINSCOT   SHIPLAP.....	18-19	BASE BLOCKS.....	40
BUILD-UPS.....	20	CASING BLOCKS.....	40-41
CASING.....	21-25	CROWN BLOCKS.....	41
ARCHITRAVES.....	26	GENERAL PURPOSE .....	42-43
BRICKS   STOOLS   BACK BANDS.....	27	HAND RAILS .....	43
STOPS   MULLIONS.....	28	JAMBS   FRAMES.....	44
BASE CAPS.....	29	PVC MOULDING .....	45
BASE.....	29-34	MOULDING INDEX .....	46
CHAIR RAIL   PANEL MOULD.....	35		

## General Information

### Species Definitions

DFIR .....	Doug Fir
DOUBLE PRIMED (FJPPD) .....	Finger Joint Primed Pine Double Pass)
FJPC .....	Finger Joint Primed Clay Coat
MAPLE .....	Maple
MAPLS .....	Maple Boards
FBDPM (MDF) .....	Primed MDF Fiber Board
OAK (OAKSL) .....	Red Oak
OAKBD .....	Oak Board
PINE .....	Pine
PINEV .....	Pine Veneer
SPINE .....	Southern Yellow Pine
FJPM .....	Finger Joint Primed Pine
POPLR   POPLAR .....	Poplar
POPBD .....	Poplar Board
POPFP .....	Poplar Finger Joint Primed
VNLVL .....	Vinyl Wrapped Wood
WHITE .....	PVC Vinyl

**Finger-Jointed Moulding** from our quality suppliers is precision milled using advanced technology in a wide selection of profiles. The advanced manufacturing methods and the woods superior moulding characteristics result in long lengths and very few defects.

- All products should be inspected for manufacturing defects prior to painting or installing.
- Please store horizontally and off the floor, and let acclimate 72 hours prior to installation.
- Install with 15-18ga pin nails with proper air pressure to counter sink fastener 1/16".
- Use light weight spackle and paintable latex caulk when filling and sand with 80-120 grit paper.
- Finish with a good quality latex paint applied following the manufacturer's specifications.

**MDF** from our quality suppliers is light-weight and manufactured using eco-friendly standards. The superior workability of our MDF mouldings offers an ease of cutting, mitering and finishing, making it excellent for any size job. The combination of light-weight substrate, consistent easy to paint surface and long lengths result in superior workmanship and a streamlined final finishing process.

- All products should be inspected for manufacturing defects prior to painting or installing.
- Please store horizontally and off the floor, and let acclimate 72 hours prior to installation.
- Install with 15-18ga pin nails with air pressure set 90-110psi to counter sink fastener 1/16".
- Use light weight spackle and paintable latex caulk when filling and sand with 80 -100 grit paper.
- Finish with a good quality latex paint applied following the manufacturer's specifications.



**NEW IN 2021** Visit [PRO.EMPIRECO.COM](http://PRO.EMPIRECO.COM) to order NOVO Building Products online



An efficient self-service online portal, which allows all Empire Moulding & Millwork dealers to access their stocked product pricing. Place orders on any desktop or mobile device to send directly to your Inside Sales Representative. Receive order status updates and shipping alerts!

Contact your Empire Sales Representative to get started today!

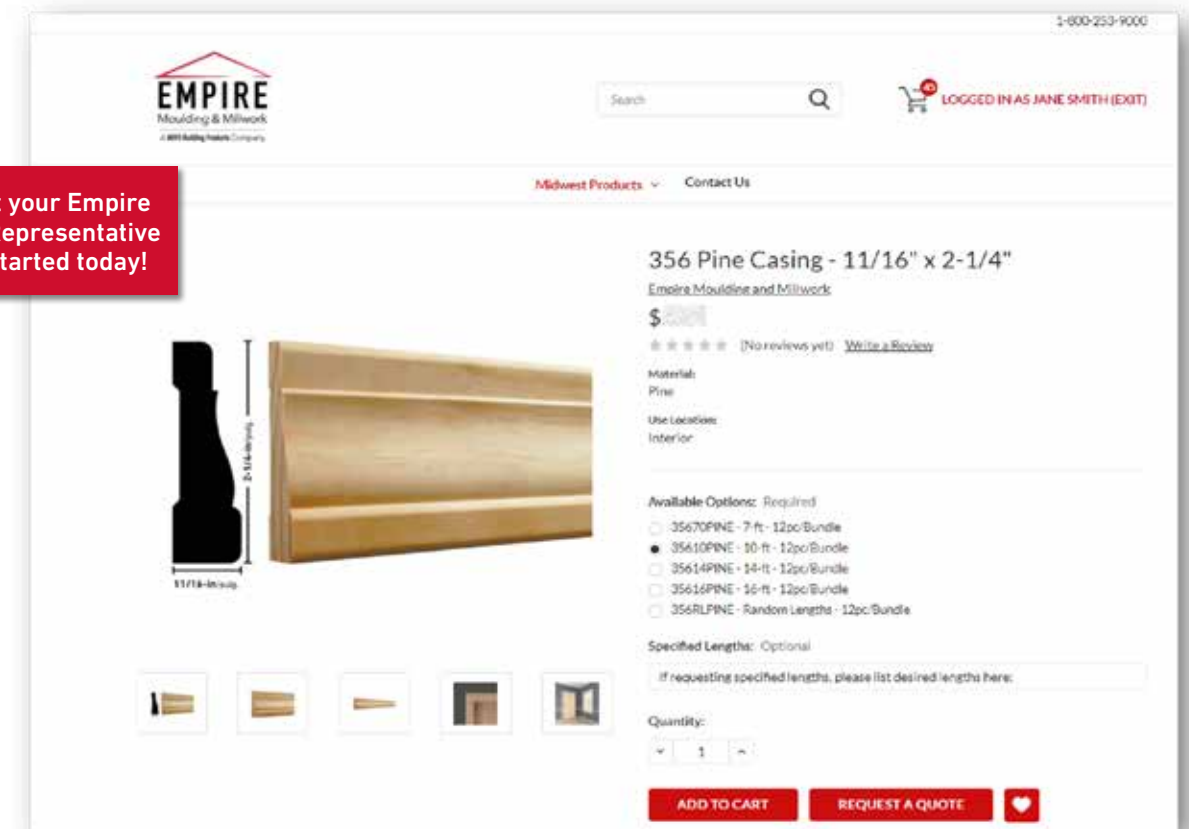

Style is individual, personal, and unique.  
Make your room a reflection of you...

# DISCOVER YOUR STYLE HERE

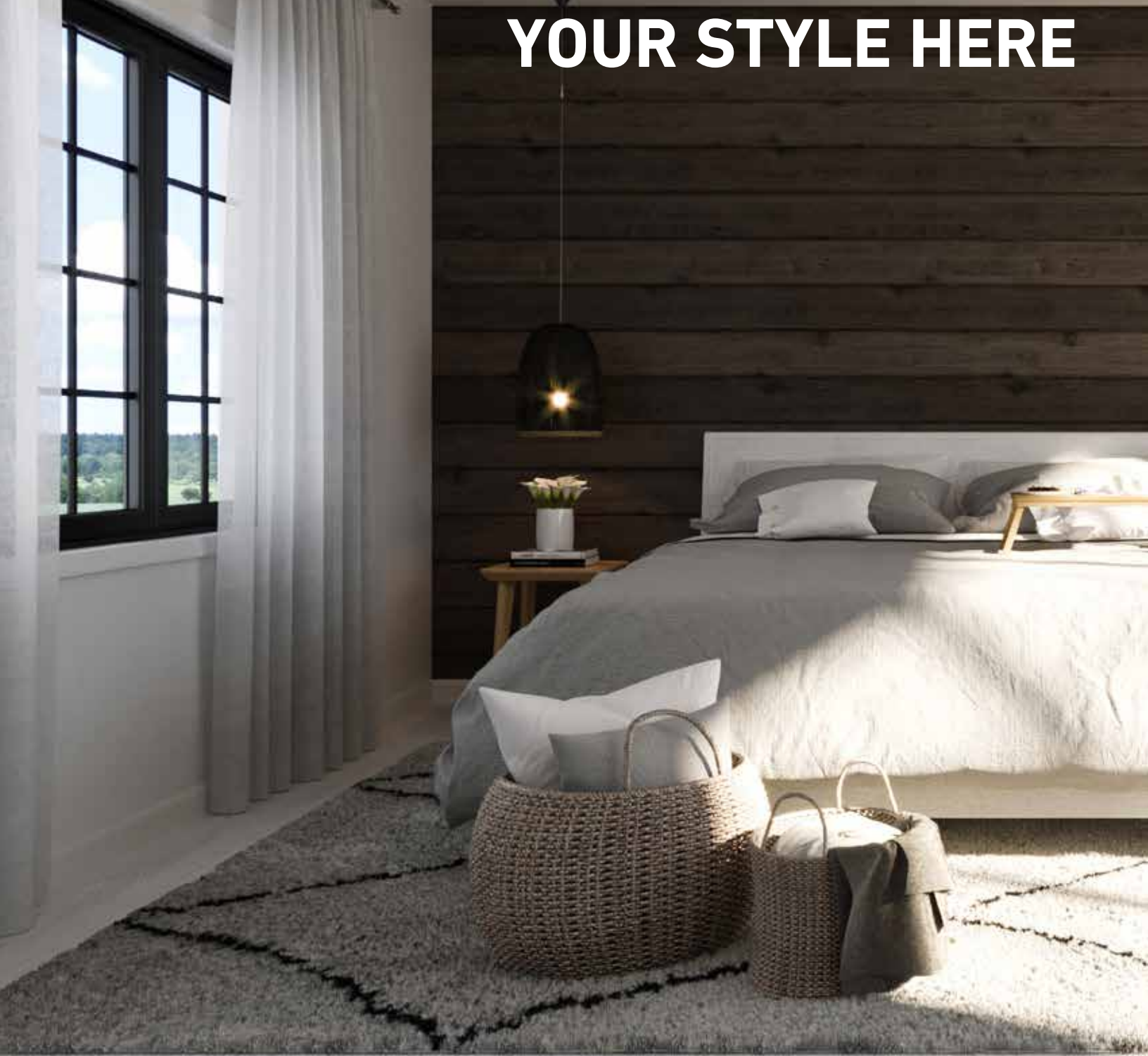

The new and improved **Empireco.com**. Explore our comprehensive collections of mouldings, stair parts, boards, and exterior millwork as well as find inspiration for every room in the home.

*Pictured: 1x6 Shiplap | 327 Casing | 713 Base*



*Achieve a similar look using: 390 Chair Rail | 51 Crown | 93 Cove | 126 Shoe | 356 Casing | H 633 Base*

## Classic

Colonial, Ranch, Traditional, Midwestern, Early American; Inviting and Timeless...

Classic Mouldings enhance any home style from Midwestern to Early American, and blend perfectly with the classic style furnishing and timeless building materials of today. Empire has a vast selection of classic style mouldings to match and enhance your style.



**356 CASING**  
5/8 x 2-1/4



**51 CROWN**  
1/2 x 3-1/4



**390 CHAIR RAIL**  
5/8 x 2-5/8



**H 633 BASE**  
1/2 x 3-1/4

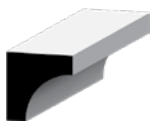

**93 COVE**  
3/4 x 3/4

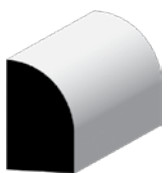

**126 SHOE**  
1/2 x 3/4



Achieve a similar look using: **1x3** S4S Board | **R SL6** Reversible Shiplap/V-Joint | **E 1035** Extended Half Round | **1x4** Casing | **1x6** Base | **126** Shoe



Achieve a similar look using: **L 47** Crown | **L 390** Chair Rail | **956W** Backer | **PT3** Casing | **163** Base Cap | **B312** Base | **126** Shoe

# Bohemian

Eclectic, Artistic, Avant-Garde; Full of life, culture, color, texture, unique and found objects.

The Bohemian look is unique as your own personality, combining color, texture, and finishes in a room that is both full of variety and styles that reflect your taste. Its is full of life and yet inviting you in to relax. Empire have a wide variety of moulding styles that can be combined to make a room as unique as you. Use any moulding style with a mix of eclectic furnishings and accessories to create a one of a kind flair.

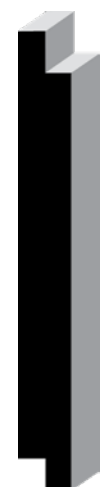

**R SL6 SHIPLAP**  
9/16 x 5



**E 1035 EXTENSION HALF ROUND**  
1/2 x 1-3/8



**1X6 BOARD**



**1X4 BOARD**



**246 S4S STOCK**  
3/4 x 2-3/4



**126 SHOE**  
1/2 x 3/4



**L 723 BASE**  
7/16 X 3-1/4

Options



**316 CASING**  
11/16 x 2-1/4

# Glam

Ornate, Art Deco, Baroque, Southern Plantation, Colonial Estate...

Decorative Mouldings can transform the bland into a bold statement of line and form. Ornate mouldings can be combined to restore a great Painted Lady or just a subtle flair and richness to add Glam to any room in your home.



**L 47 CROWN**  
9/16 x 4-5/8



**956W BACKER BEAD**  
1/2 x 4-1/4



**L 390 CHAIR RAIL**  
9/16 x 2-5/8



**PT3 CASING**  
1 x 3-1/4



**B 312 BASE**  
19/32 x 5-1/4



**163 BASE CAP**  
11/16 x 1-3/8

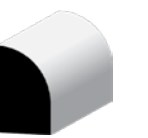

**126 SHOE**  
1/2 x 3/4



Achieve a similar look using: **1x4 EC** Wainscoting | **L 340** Crown | **1x6** Shiplap | **5010** Architrave | **E412 E2E** Casing | **512E E1E** Base | **126** Shoe



Achieve a similar look using: **E519** Crown | **5010** Architrave | **G412** Casing | **G514** Base | **L 254** Shoe

# Rustic

Natural and Painted Woods, Handcrafted, Cottage, Frontier Simplicity...

Empire stocks a wide variety of hardwood and primed mouldings, boards, and wall panels from wainscoting, bead-board to shiplap that combine to create a rich rustic space. From ceiling to walls, fill your home with the timeless warmth and comfort of simpler days.



**1 X 4**  
TRIM BOARD



**1 X 6**  
SHIPLAP



**WOOD**

**WOODSHED**  
4 WOOD RBWPP 8'  
6 WOOD RBWPP 8'



**SIL0**

**SIL0**  
4 SIL0 RBWPP 8'  
6 SIL0 RBWPP 8'

## Rough Sawn Barnwood

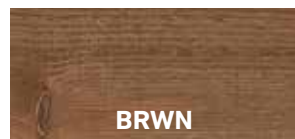

**BRWN**

**BROWN**  
4 BRWN RRSSH 8'  
6 BRWN RRSSH 8'

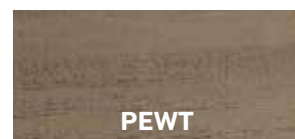

**PEWT**

**PEWTER**  
4 PEWT RRSSH 8'  
6 PEWT RRSSH 8'



**CHAR**

**CHARCOAL**  
4 CHAR RRSSH 8'  
6 CHAR RRSSH 8'

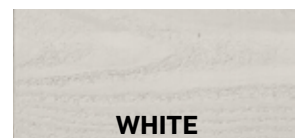

**WHITE**

**WHITE**  
4 WHITE RRSSH 8'  
6 WHITE RRSSH 8'

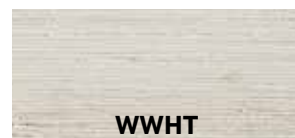

**WWHT**

**WEATHERED WHITE**  
4 WWHT RBWPP 8'  
6 WWHT RBWPP 8'

# Craftsman

Handcrafted, Architectural, Craftsman, Modern-Farmhouse, Western Ranch...

Craftsman Mouldings are unique in their adaptability to style from Modern Industrial, Arts and Crafts Architectural and Bungalow to Modern-Farmhouse and Art Deco. They are easily combined with other mouldings complimenting your style.



**E519**  
**CROWN**  
9/16 x 4-1/4



**5010**  
**ARCHITRAVE**  
1-3/16 x 4-1/4



**G412**  
**CASING**  
19/32 x 3-1/2



**G514**  
**BASE**  
1/2 x 5-1/4

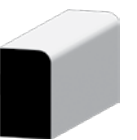

**L254**  
**SHOE**  
7/16 x 3/4

Crown

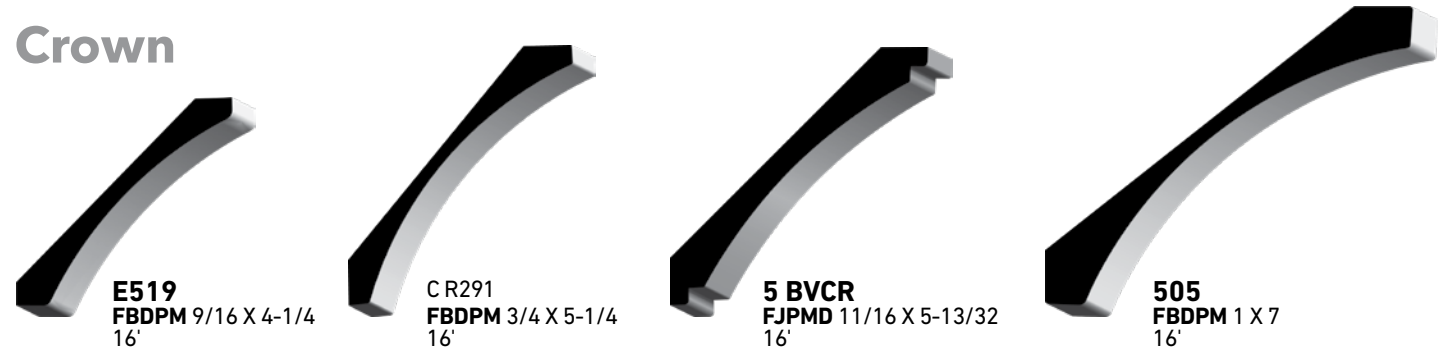

Base

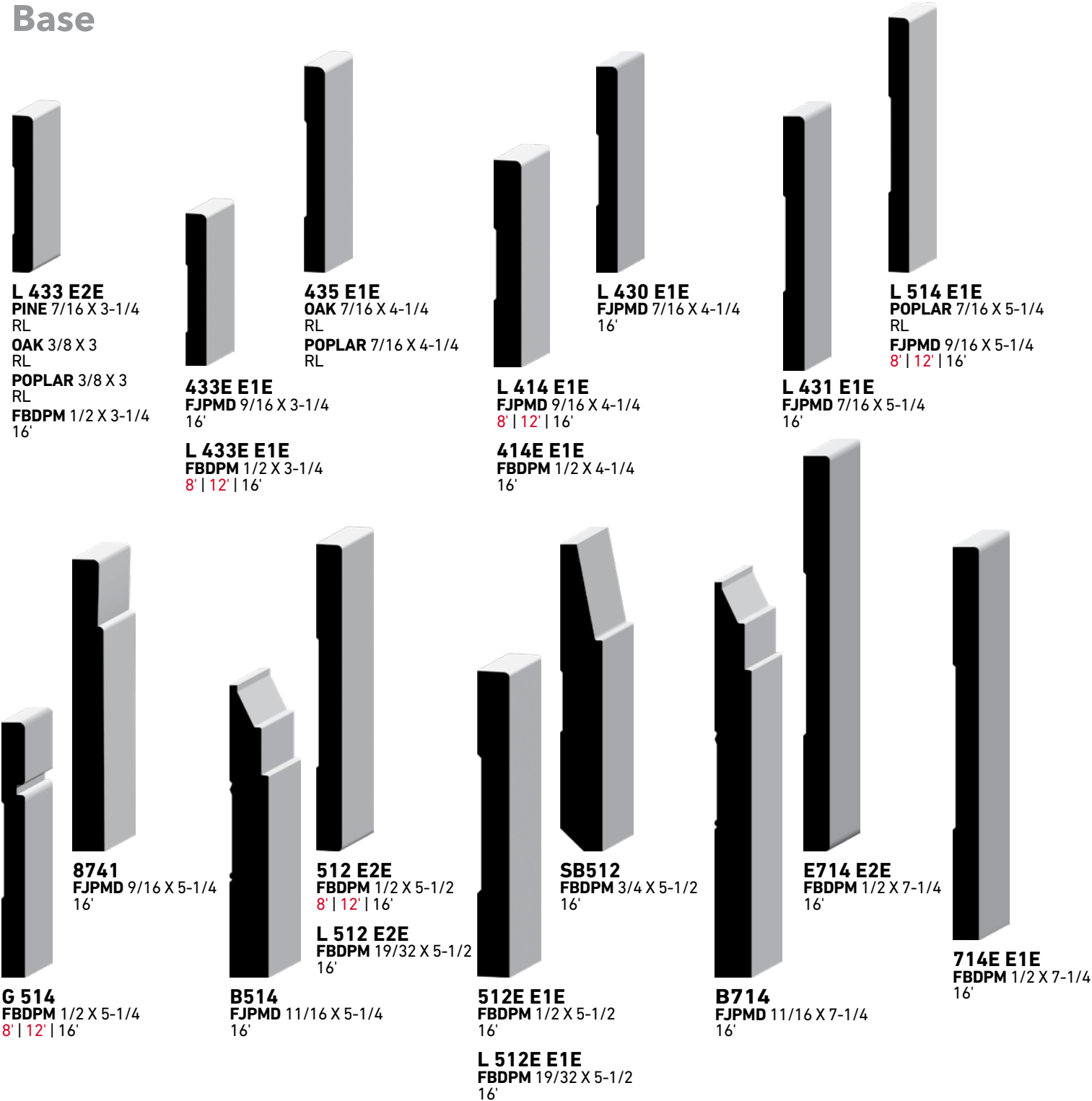

Miscellaneous

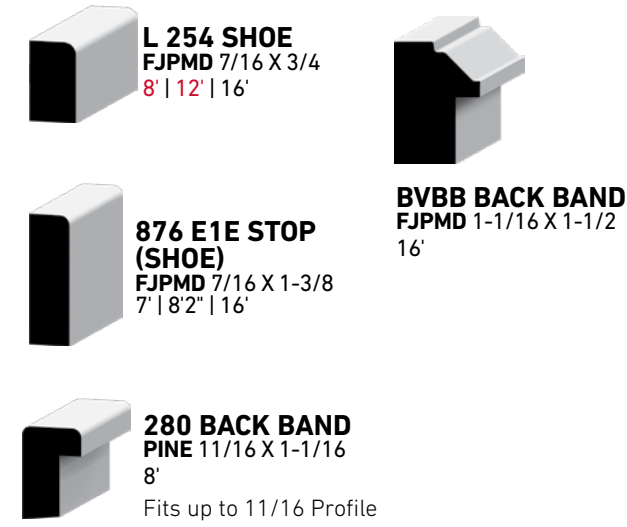

Casing

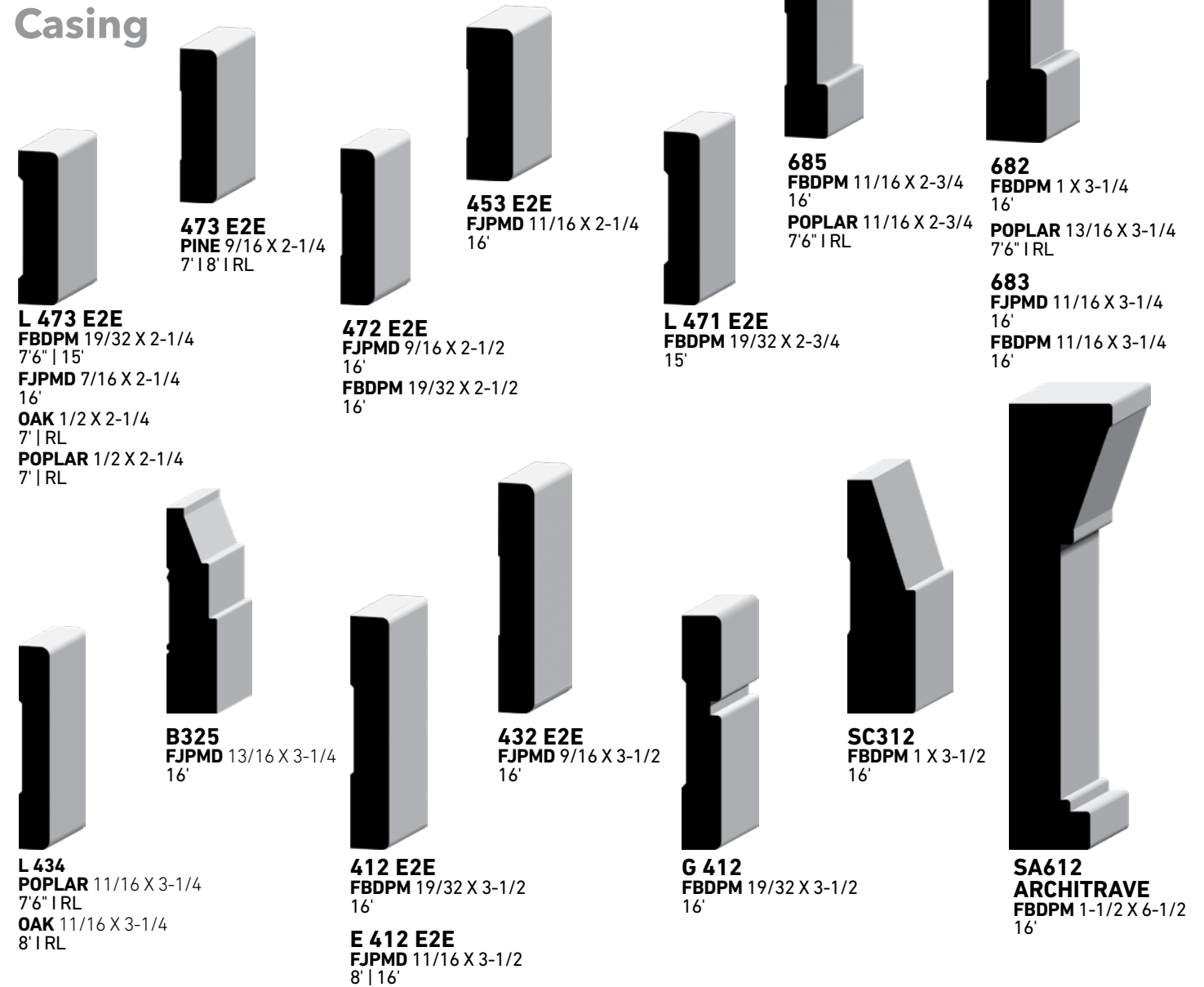



# Boards

Versatile, Tactile, Craftable, Stainable, Paintable...  
Adaptable to any style...

When most people think of BOARDS they think of the internal structure of the walls, something never seen; we see the versatility to create unique spaces. BOARDS used to create spaces that are warm, timeless or modern; bring you in to focus your attention or just make you feel at home. From Hardwoods to versatile composites, wainscots and shiplaps, our redefining boards will redefine your home.

MDF-18MM E2E BOARDS		
E 14 FBDPM	18mm x 3-1/2	16'
E 16 FBDPM	18mm x 5-1/2	16'
E 18 FBDPM	18mm x 7-1/4	16'
MDF-18MM S4S BOARDS		
14 FBDPM	18mm x 3-1/2	16'
16 FBDPM	18mm x 5-1/2	16'
18 FBDPM	18mm x 7-1/4	16'
110 FBDPM	18mm x 9-1/4	16'
112 FBDPM	18mm x 11-1/4	16'
MDF-25MM S4S BOARDS		
54X4 FBDPM	25mm X 3-1/2	8'   16'
54X6 FBDPM	25mm x 5-1/2	8'   16'
54X8 FBDPM	25mm x 7-1/4	8'   16'
54X12 FBDPM	25mm X 11-1/4	8'   16'
MDF-17MM E2E BOARDS		
E 12 FBDPM	17mm (11/16) X 1-1/2	8'
E 13 FBDPM	17mm (11/16) X 2-1/2	8'
E 14 FBDPM	17mm (11/16) X 3-1/2	8'   12'
7 E14 FBDPM	17mm (11/16) X 3-1/2	16'
E 16 FBDPM	17mm (11/16) X 5-1/2	8'   12'
7 E16 FBDPM	17mm (11/16) X 5-1/2	16'
E 18 FBDPM	17mm (11/16) X 7-1/4	8'
7 E18 FBDPM	17mm (11/16) X 7-1/4	16'
7 E110 FBDPM	17mm (11/16) X 9-1/4	16'
E 112 FBDPM	17mm (11/16) X 11-1/4	8'
7 E112 FBDPM	17mm (11/16) X 11-1/4	16'

MDF-17MM S4S BOARDS		
L 13 FBDPM	17mm(11/16) X 2-1/2	8'
L 14 FBDPM	17mm(11/16) X 3-1/2	8'   12'
L 16 FBDPM	17mm(11/16) X 5-1/2	8'   12'
L 18 FBDPM	17MM(11/16) X 7-1/4	8'
MDF-MDF PAINTED WHITE BOARDS		
E 12 FBDWH	11/16 x 1-1/2	8'   12'
E 13 FBDWH	11/16 x 2-1/2	8'   12'
E 14 FBDWH	11/16 x 3-1/2	8'   12'
E 16 FBDWH	11/16 x 5-1/2	8'   12'
E 18 FBDWH	11/16 x 7-1/4	8'   12'
E 54X4 FBDWH	1 x 3-1/2	8'   12'

ULTRALITE MDF SHEETS		Sold in full units only (approx 53 sheets per unit)
L344 8 FBD8A	3/4" x 4' x 8'	

PAINTED E2E WHITE BOARDS		
E 14 FJPDWH	11/16 x 3-1/2	8'
E 16 FJPDWH	11/16 x 5-1/2	8'   12'

FJ PRIMED		
L 248 FJPM	11/16 X 1-3/4	16'
L 246 FJPM	11/16 X 2-3/4	16'
T 1X4 FJPM	23/32 X 3-1/2	16'
T 1X6 FJPM	23/32 X 5-1/2	16'
T 1X8 FJPM	23/32 X 7-1/4	16'
T 1X10 FJPM	23/32 X 9-1/4	16'
T 1X12 FJPM	23/32 X 11-1/4	16'
1X2 FJPM	23/32 X 1-1/2	8'   12'
1X3 FJPM	23/32 X 2-1/2	8'
1X4 FJPM	23/32 X 3-1/2	8'   12'   16'
1X6 FJPM	23/32 X 5-1/2	8'   12'   16'
1X8 FJPM	23/32 X 7-1/4	8'   12'   16'
1X10 FJPM	23/32 X 9-1/4	16'
1X12 FJPM	23/32 X 11-1/4	8'   16'
54X4 FJPM	1-1/16 X 3-1/2	16'
54X6 FJPM	1-1/16 X 5-1/2	12'   16'
54X8 FJPM	1-1/16 X 7-1/4	16'
5410 FJPM	1-1/16 X 9-1/4	16'
5412 FJPM	1-1/16 X 11-1/4	16'

CLEAR PINE - RADIATA BOARDS			
38X2 RPC	3/8 X 1-1/2	2'   3'	
38X3 RPC	3/8 X 2-1/2	2'   3'	
38X4 RPC	3/8 X 3-1/2	2'   3'	
38X6 RPC	3/8 X 5-1/2	2'   3'	
12X2 RPC	1/2 X 1-1/2	2'   3'	
12X3 RPC	1/2 X 2-1/2	2'   3'	
12X4 RPC	1/2 X 3-1/2	2'   3'	
12X6 RPC	1/2 X 5-1/2	2'   3'	
2X2 RPC	1-1/2 X 1-1/2	6'   8'	
L 248 PINE	11/16 X 1-3/4	8'   RL	
L 246 PINE	11/16 X 2-3/4	RL	
1X2 RPC	3/4 X 1-1/2	4'   6'   8'	
1X3 RPC	3/4 X 2-1/2	4'   6'   8'	
1X4 RPC	3/4 X 3-1/2	4'   6'   8'   10'   12'   14'   16'	
1X6 RPC	3/4 X 5-1/2	4'   6'   8'   10'   12'   14'   16'	
1X8 RPC	3/4 X 7-1/4	4'   8'   10'   12'   14'   16'	
1X10 RPC	3/4 X 9-1/4	4'   8'   10'   12'   14'   16'	
1X12 RPC	3/4 X 11-1/4	4'   8'   10'   12'   14'   16'	
54X4 RPC	1-1/4 X 3-1/2	6'   8'	
54X6 RPC	1-1/4 X 5-1/2	6'   8'	
Mini Packs - sold in Unit Quantities Listed Only		Approx. Unit Quantity	
M1X4 RPC	3/4 X 3-1/2	RL	1500'
M1X6 RPC	3/4 X 5-1/2	RL	1000'
M1X8 RPC	3/4 X 7-1/4	RL	750'
M1X10 RPC	3/4 X 9-1/4	RL	600'
M1X12 RPC	3/4 X 11-1/4	RL	500'

#2 PINE BOARDS			
1X2 WWP2	3/4 x 1-1/2	4'   6'   8'	
1X3 WWP2	3/4 x 2-1/2	4'   6'   8'	
1X4 WWP2	3/4 x 3-1/2	4'   6'   8'   10'   12'	
1X6 WWP2	3/4 X 5-1/2	4'   6'   8'   10'   12'	
1X8 WWP2	3/4 X 7-1/4	6'   8'   10'   12'	
1X10 WWP2	3/4 X 9-1/4	6'   8'   10'   12'	
1X12 WWP2	3/4 X 11-1/4	4'   6'   8'   10'   12'	



PINE PANELS		
STAIN GRADE EDGE GLUED PANEL		
1236 SGPNL	3/4 X 12 X 36	36
1248 SGPNL	3/4 X 12 X 48	48
1272 SGPNL	3/4 X 12 X 72	72
1636 SGPNL	3/4 X 16 X 36	36
1648 SGPNL	3/4 X 16 X 48	48
1672 SGPNL	3/4 X 16 X 72	72
1696 SGPNL	3/4 X 16 X 96	96
1824 SGPNL	3/4 X 18 X 24	24
2036 SGPNL	3/4 X 20 X 36	36
2048 SGPNL	3/4 X 20 X 48	48
2072 SGPNL	3/4 X 20 X 72	72
2096 SGPNL	3/4 X 20 X 96	96
2424 SGPNL	3/4 X 24 X 24	24
2436 SGPNL	3/4 X 24 X 36	36
2448 SGPNL	3/4 X 24 X 48	48
2472 SGPNL	3/4 X 24 X 72	72
R 1X15 SGPNL	15"	
R 1X18 SGPNL	18"	
R 1X24 SGPNL	24"	
R 1X36 SGPNL	36"	

PINE PANELS		
PAINT GRADE PANEL		
1236 PGPNL	21/32 X 12 X 36	36
1272 PGPNL	21/32 X 12 X 72	72
1296 PGPNL	21/32 X 12 X 96	96
1636 PGPNL	21/32 X 16 X 36	36
1648 PGPNL	21/32 X 16 X 48	48
1672 PGPNL	21/32 X 16 X 72	72
1696 PGPNL	21/32 X 16 X 96	96

CEDAR			
F 1X2 CEDAR	11/16 X 1-1/2 S4S	8'	
F 1X4 CEDAR	11/16 X 3-1/2 S4S	8'   10'   12'	
F 1X6 CEDAR	11/16 X 5-1/2 S4S	8'   12'	
F 1X8 CEDAR	11/16 X 7-1/4 S4S	8'   12'	
P 1X6 CEDAR	11/16 X 5-1/2 T&G	8'   12'	



POPLAR			
P 14X2 POPBD	1/4 X 1-1/2	4'	
P 14X3 POPBD	1/4 X 2-1/2	4'	
P 14X4 POPBD	1/4 X 3-1/2	4'	
P 14X6 POPBD	1/4 X 5-1/2	4'	
P 12X2 POPBD	1/2 X 1-1/2	4'	
P 12X3 POPBD	1/2 X 2-1/2	4'	
P 12X4 POPBD	1/2 X 3-1/2	4'	
P 12X6 POPBD	1/2 X 5-1/2	4'	
P 1X2 POPBD	3/4 X 1-1/2	2'   4'   6'   8'   10'   12'	
P 1X3 POPBD	3/4 X 2-1/2	2'   4'   6'   8'   10'	
P 1X4 POPBD	3/4 X 3-1/2	2'   4'   6'   8'   10'   12'   14'   16'	
P 1X6 POPBD	3/4 X 5-1/2	2'   4'   6'   8'   10'   12'   14'   16'	
P 1X8 POPBD	3/4 X 7-1/4	2'   4'   6'   8'   10'   12'   14'   16'	
P 1X10 POPBD	3/4 X 9-1/4	8'   10'   12'   14'   16'	
P 1X12 POPBD	3/4 X 11-1/4	2'   4'   6'   8'   10'   12'   14'   16'	
54X4 POPBD	1-1/16 X 3-1/2	RL	
54X6 POPBD	1-1/16 X 5-1/2	RL	
54X8 POPBD	1-1/16 X 7-1/4	RL	
54X10 POPBD	1-1/16 X 11-1/4	RL	
54X12 POPBD	1-1/16 X 11-1/4	RL	
P 2X2 POPBD	1-1/2 X 1-1/2	3'	
P 3X3 POPBD	2-1/2 X 2-1/2	3'	
248 POPLR	3/4 X 1-3/4	8'   RL	
246 POPLR	3/4 X 2-3/4	RL	
Mini Packs - sold in Unit Quantities Listed Only			Approx. Unit Quantity
M 1X4 POPBD	3/4 X 3-1/2	RL	750'
M 1X6 POPBD	3/4 X 5-1/2	RL	500'
M 1X8 POPBD	3/4 X 7-1/4	RL	375'
M 1X10 POPBD	3/4 X 9-1/4	RL	300'
M 1X12 POPBD	3/4 X 11-1/4	RL	250'

POPLAR PRIMED		
1X4 POPFP	3/4 X 3-1/2	16'
1X6 POPFP	3/4 X 5-1/2	16'
1X8 POPFP	3/4 X 7-1/4	16'
1X12 POPFP	3/4 X 11-1/4	16'

OAK			
R 14X2 OAKSL	1/4 X 1-1/2	4'	
R 14X3 OAKSL	1/4 X 2-1/2	4'	
R 14X4 OAKSL	1/4 X 3-1/2	4'	
R 14X6 OAKSL	1/4 X 5-1/2	4'	
R 12X2 OAKSL	1/2 X 1-1/2	4'	
R 12X3 OAKSL	1/2 X 2-1/2	4'	
R 12X4 OAKSL	1/2 X 3-1/2	4'	
R 12X6 OAKSL	1/2 X 5-1/2	4'	
R 1X2 OAKSL	3/4 X 1-1/2	4'   6'   8'	
R 1X3 OAKSL	3/4 X 2-1/2	4'   6'   8'	
R 1X4 OAKSL	3/4 X 3-1/2	4'   6'   8'   10'   12'   14'   16'	
R 1X6 OAKSL	3/4 X 5-1/2	4'   6'   8'   10'   12'   14'   16'	
R 1X8 OAKSL	3/4 X 7-1/4	4'   6'   8'   10'   12'   14'   16'	
R 1X10 OAKSL	3/4 X 9-1/4	8'   10'   12'   14'   16'	
R 1X12 OAKSL	3/4 X 11-1/4	4'   6'   8'   10'   12'   14'	
R 2X2 OAKSL	1-1/2 X 1-1/2	3'	
R 3X3 OAKSL	2-1/2 X 2-1/2	3'	
248 OAKSL	3/4 X 1-3/4	8'   RL	
246 OAKSL	3/4 X 2-3/4	8'	
Mini Packs - sold in Unit Quantities Only			Approx. Unit Quantity
M 1X4 OAKSL	3/4 X 3-1/2	RL	750'
M 1X6 OAKSL	3/4 X 5-1/2	RL	500'
M 1X8 OAKSL	3/4 X 7-1/4	RL	375'
M 1X10 OAKSL	3/4 X 9-1/4	RL	300'
M 1X12 OAKSL	3/4 X 11-1/4	RL	250'

OAK VENEER SKIRT BOARDS		
1X10 OAKVS	3/4 X 9-1/4	16'
1X12 OAKVS	3/4 X 11-1/4	16'



Lengths listed in RED are subject to availability

MAPLE		
Mini Packs - sold in Unit Quantities Only		
M 1X4 MAPLS	3/4 X 3-1/2	RL
M 1X6 MAPLS	3/4 X 5-1/2	RL
M 1X8 MAPLS	3/4 X 7-1/4	RL
M 1X10 MAPLS	3/4 X 9-1/4	RL

MAPLE VENEER SKIRT BOARDS		
1X12 MAPV4	3/4 X 11-1/4	16'

ROYAL PVC BOARDS - TRIMPRO BOARDS		
1157 WHITE	3/4 X 1-1/2	8'
1181 WHITE	3/4 X 1-1/2	12'
9096 WHITE	3/4 X 3-1/2	8'
9109 WHITE	3/4 X 3-1/2	12'
9117 WHITE	3/4 X 5-1/2	8'
9125 WHITE	3/4 X 5-1/2	12'
9133 WHITE	3/4 X 7-1/4	8'
9141 WHITE	3/4 X 7-1/4	12'
9176 WHITE	3/4 X 9-1/4	8'
9184 WHITE	3/4 X 9-1/4	12'
9299 WHITE	54X4 1X3-1/2	10'
9301 WHITE	54X6 1X5-1/2	10'
ROYAL PVC BOARDS - TRIMPLANK BOARDS		
7318 WHITE	3/4 X 3-1/2	8'   12'
7311 WHITE	3/4 X 5-1/2	8'   12'
PVC PANEL		
2878 WHITE	3/8 X 4 X 8	PANEL FLAT



Lengths listed in RED are subject to availability

MDF WAINSCOTING / SHIPLAP (FBDPM)		
SL16 FBDPM	11/16 X 5-1/4 T&G Shiplap	16'
SL18 FBDPM	11/16 X 7-1/4 T&G Shiplap	16'
WC16 FBDPM	19/32 X 5 Wainscoting	16'
L WP4 FBDPM	19/32 X 5 Wainscoting	16'
L SBW4 FBDPM	19/32 X 5-1/4 Wainscoting	16'
L BEAD FBDPM	19/32 X 5-1/4 Wainscoting	16'
PREFINISHED MDF SHIPLAP (WHITE) (GREY)		
M SL16 FBDWH	12.7mm X 5-1/2 Painted White Shiplap	8'   12'
L SL16 FBWGY	1/2 X 5-1/4 Painted Wintucket Gray Shiplap	8'
FJ PRIMED WAINSCOTING / BEADED CEILING / SHIPLAP (FJPM)		
1X4 EC FJPM	23/32 X 3-1/2 Wainscoting	16'
1X6 EC FJPM	23/32 X 5-1/2 Wainscoting	16'
L SL16 FJPM	5/8 X 5-3/8 Shiplap	8'   16'
L SL18 FJPM	5/8 X 7-3/8 Shiplap	8'   16'
SL6 LVLPM	13.7mm X 5-3/8 LVL Ship Lap Nickel Gap	8'   12'
SL8 LVLPM	13.7mm X 7-1/4 LVL Ship Lap Nickel Gap	8'   12'



PINE PATTERN STOCK / SHIPLAPS		
ECB4 IWPPS	11/16 X 3-1/8 C&BTR Pine Beaded Ceiling	8'   12'
WP18 WWP2	11/16 X 7-1/8 #2 Pine Wp4/Wp18 Pattern Stock	8'   12'
R SL6 IWPP2	9/16 X 5 Pine Reversible Shiplap/V Joint	8'   12'

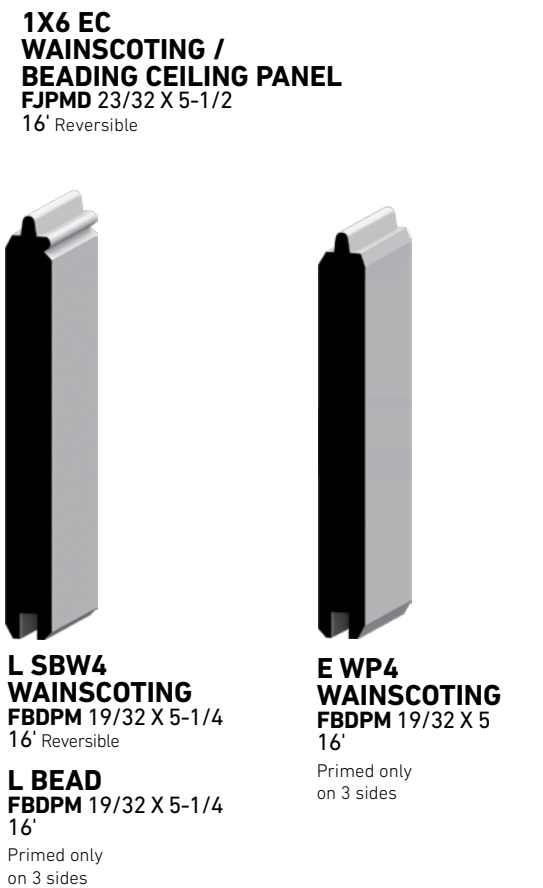
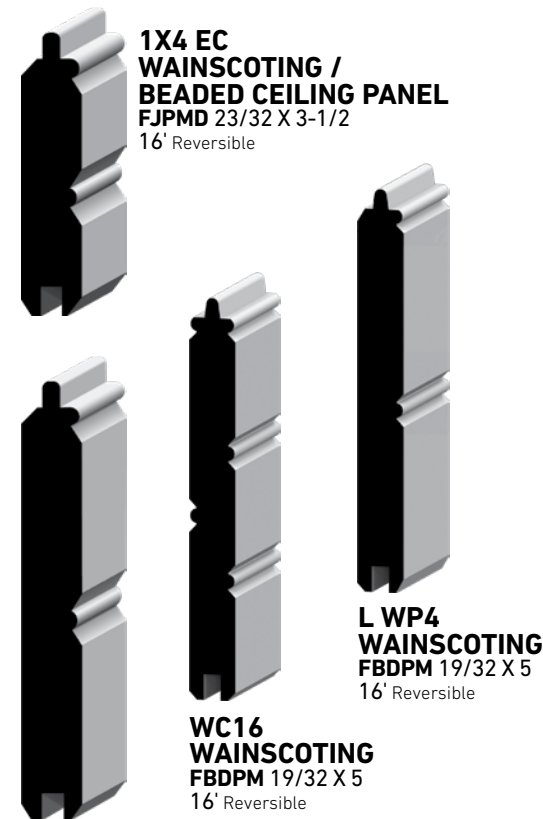

1X4 RUSTIC BARNWOOD TRIM BOARD (RBWPP)		
4 WOOD RBWPP	5/8 X 3-1/2 Trim Board - Woodshed	8'
4 SILO RBWPP	5/8 X 3-1/2 Trim Board - Silo	8'
4 WWHT RBWPP	5/8 X 3-1/2 Trim Board - White	8'   12'
1X6 RUSTIC BARNWOOD SHIPLAP (RBWPP)		
6 WOOD RBWPP	11/16 X 5-3/8 Shiplap - Woodshed	8'
6 SILO RBWPP	11/16 X 5-3/8 Shiplap - Silo	8'
6 WWHT RBWPP	11/16 X 5-3/8 Shiplap - White	8'
1X4 RUSTIC ROUGH SAWN BARNWOOD TRIM BOARD (RRSSH)		
4 BRWN RRSSH	5/8 X 3-1/2 Trim Board - Brown	8'
4 WHITE RRSSH	5/8 X 3-1/2 Trim Board - White	8'
4 PEWT RRSSH	5/8 X 3-1/2 Trim Board - Pewter	8'
4 CHAR RRSSH	5/8 X 3-1/2 Trim Board - Charcoal	8'
1X6 RUSTIC ROUGH SAWN BARNWOOD SHIPLAP (RRSSH)		
6 BRWN RRSSH	5/8 X 5-3/8 Shiplap - Brown	8'
6 WHITE RRSSH	5/8 X 5-3/8 Shiplap - White	8'
6 PEWT RRSSH	5/8 X 5-3/8 Rough Sawn Shiplap Pewter	8'
6 CHAR RRSSH	5/8 X 5-3/8 Rough Sawn Shiplap Charcoal	8'

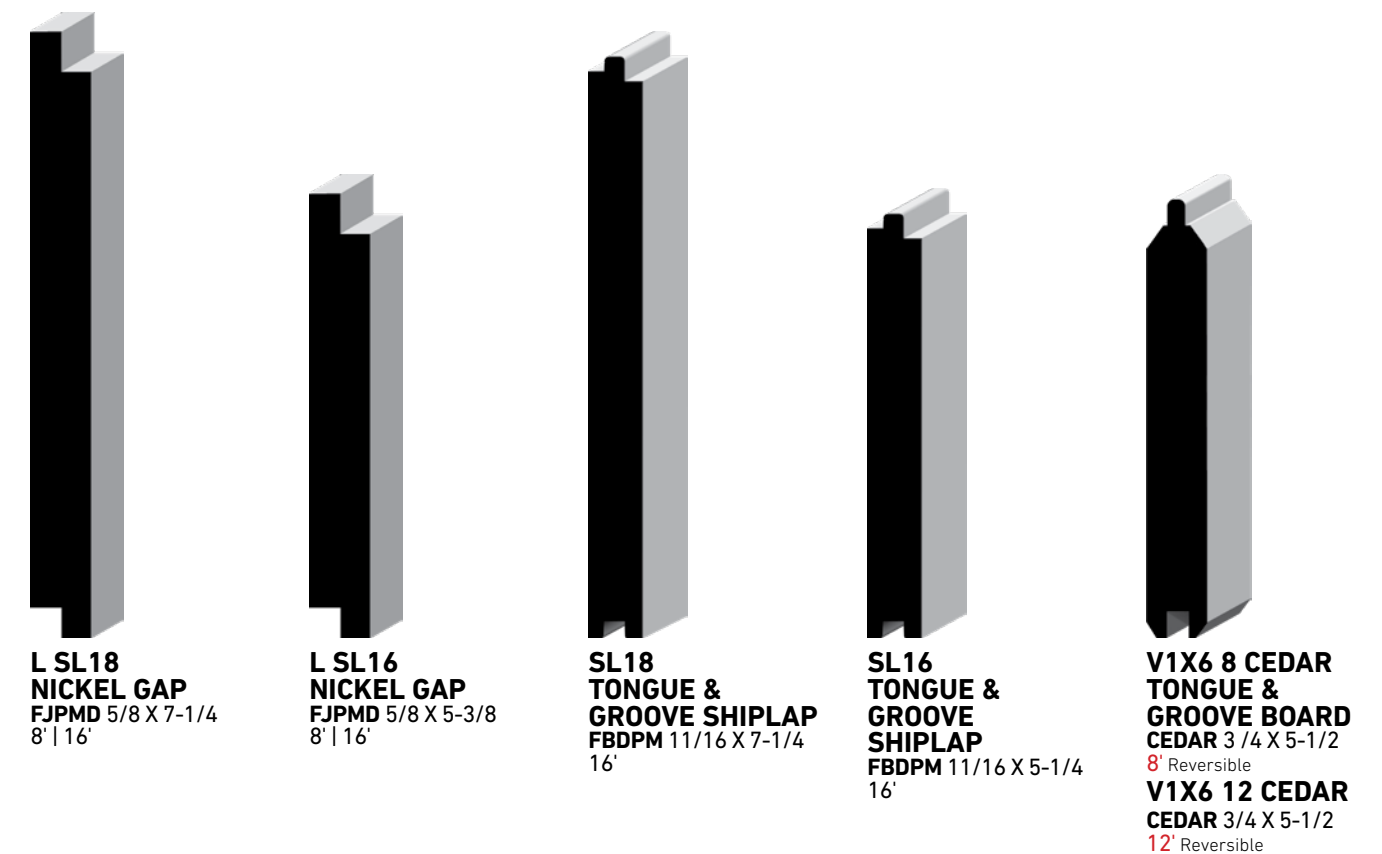

# Build-Ups

## Combine moulding patterns to create a unique home style.

- Combine crowns, bases, casing, panel moulds, shoe or quarter rounds and more, to create detail, line and pattern.
- Use boards or square stock to build up depth.
- Combine square and eased edges to create richer detail.
- Use moulding with the same style families for a harmonious feel.
- Create completely unique build-ups to fit your own style.



Build-Up Option

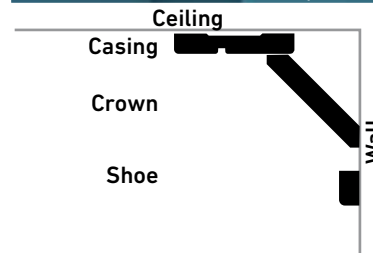

Build-Up Option

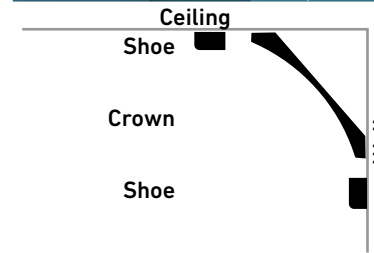

## Chair Rail



Ⓐ Cove  
Ⓑ S4S  
Ⓒ Chair Rail

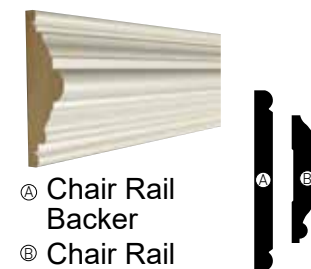

Ⓐ Chair Rail Backer  
Ⓑ Chair Rail

## Casing



Ⓐ Stop  
Ⓑ Casing  
Ⓒ Cove



Ⓐ Cove  
Ⓑ Casing  
Ⓒ Shoe

## Crown

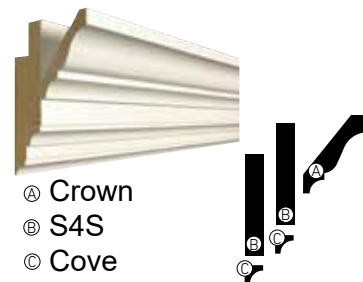

Ⓐ Crown  
Ⓑ S4S  
Ⓒ Cove

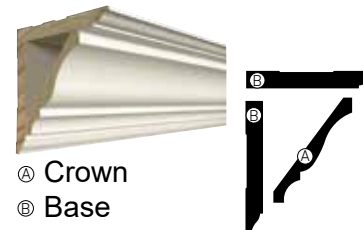

Ⓐ Crown  
Ⓑ Base

## Base

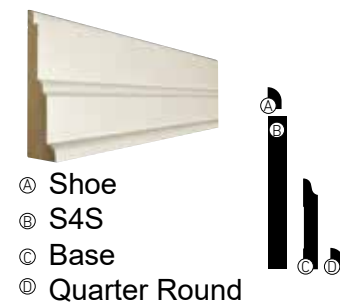

Ⓐ Shoe  
Ⓑ S4S  
Ⓒ Base  
Ⓓ Quarter Round



Ⓐ Cap  
Ⓑ S4S  
Ⓒ Quarter Round

## Casing



**316**  
PINE 11/16 X 2-1/4  
7' | 10' | 14'  
FJPM 11/16 X 2-1/4  
7' | 10' | 14'  
OAK 5/8 X 2-1/4  
7' | RL



**321**  
PINE 11/16 X 2-1/4  
7' | RL



**324**  
PINE 11/16 X 2-1/4  
7' | RL

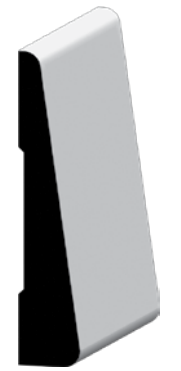

**L 324**  
OAK 1/2 X 2-1/4  
7' | RL



**327**  
PINE 11/16 X 2-1/4  
7' | 8' | 10' | 14' | RL  
FJPM 11/16 X 2-1/4  
7' | 14'



**L 356**  
OAK 1/2 X 2-1/4  
7' | 10'



**366**  
PINE 11/16 X 2-1/4  
7' | 10' | 14'  
FJPM 11/16 X 2-1/4  
7' | 10' | 14'  
FJPC 11/16 X 2-1/4  
14'



**356**  
PINE 11/16 X 2-1/4  
7' | 8' | 10' | 14' | 16' | RL  
FJPM 11/16 X 2-1/4  
7' | 10' | 14'  
FJPC 11/16 X 2-1/4  
7' | 14'  
OAK 5/8 X 2-1/4  
7' | 8' | 10' | 12' | RL  
POPLAR 5/8 X 2-1/4  
7' | RL  
FBDPM 19/32 X 2-1/4  
14'

**N356**  
FBDPM 19/32 X 2-1/4  
7'



**L 366 (14mm)**  
FBDPM 9/16 X 2-1/4  
7'  
FJPC 9/16 X 2-1/4  
15'



**366A**  
FBDPM 19/32 X 2-1/4  
14'



**376**  
FBDPM 19/32 X 2-1/4  
14'



**473 E2E**  
PINE 9/16 X 2-1/4  
7' | 8' | RL

Casing



**L 473 E2E**  
**FBDPM** 19/32 X 2-1/4  
 7'6" | 15'  
**FJPM** 7/16 X 2-1/4  
 16'  
**OAK** 1/2 X 2-1/4  
 7' | RL  
**POPLAR** 1/2 X 2-1/4  
 7' | RL



**453 E2E**  
**FJPC** 11/16 X 2-1/4  
 16'



**472 E2E**  
**FJPC** 9/16 X 2-1/2  
 16'  
**FBDPM** 19/32 X 2-1/2  
 16'



**361**  
**PINE** 11/16 X 2-1/2  
 7' | RL  
**FJPM** 11/16 X 2-1/2  
 7' | 10'  
**FJPC** 11/16 X 2-1/2  
 14'  
**FBDPM** 19/32 X 2-1/2  
 14'  
**OAK** 9/16 x 2-1/2  
 RL  
**S361**  
**FBDPM** 9/16 X 2-1/2  
 7'



**411**  
**FBDPM** 11/16 X 3  
 16'



**40**  
**OAK** 9/16 X 3-1/4  
 RL



**L 366**  
**FJPC** 11/16 X 3-1/4  
 15'



**351**  
**PINE** 11/16 X 2-1/2  
 7' | 14'  
**FJPM** 11/16 X 2-1/2  
 7' | 14'



**474**  
**FJPC** 11/16 X 2-3/4  
 15'  
**OAK** 11/16 X 2-3/4  
 7'4" | RL



**4520**  
**FBDPM** 11/16 X 2-3/4  
 15'



**P 380**  
**PINE** 11/16 X 2-3/4  
 RL  
**FJPM** 11/16 X 2-3/4  
 7'4"  
**FJPC** 11/16 X 2-3/4  
 7'6" | 15'  
**FBDPM** 11/16 X 2-3/4  
 16'  
**POPLAR** 11/16 X 2-3/4  
 7'4" | RL



**445**  
**PINE** 11/16 X 3-1/4  
 8'  
**FJPM** 11/16 X 3-1/4  
 8' | 11'  
**FJPC** 11/16 X 3-1/4  
 15'



**445A**  
**FBDPM** 11/16 X 3-1/4  
 16'



**L 444**  
**PINE** 11/16 X 3-1/4  
 8' | 16' | RL  
**FJPC** 11/16 X 3-1/4  
 7'6" | 15'  
**POPLAR** 11/16 X 3-1/4  
 7'6" | RL  
**FBDPM** 19/32 X 3-1/4  
 16'  
**OAK** 3/4 X 3-1/4  
 7'4" | 18" | RL



**L 471 E2E**  
**FBDPM** 19/32 X 2-3/4  
 15'



**685**  
**FBDPM** 11/16 X 2-3/4  
 16'  
**POPLAR** 11/16 X 2-3/4  
 7'6" | RL



**L FLTD**  
**PINE** 7/16 X 3  
 7'



**312**  
**FBDPM** 19/32 X 3  
 8' | 116'



**L 434**  
**POPLAR** 11/16 X 3-1/4  
 7'6" | RL  
**OAK** 11/16 X 3-1/4  
 8' | RL



**B325**  
**FJPM** 13/16 X 3-1/4  
 16'



**683**  
**FJPC** 11/16 X 3-1/4  
 16'  
**FBDPM** 11/16 X 3-1/4  
 16'



**682**  
**FBDPM** 1 X 3-1/4  
 16'  
**POPLAR** 13/16 X 3-1/4  
 7'6" | RL

Casing

Casing

Casing



**L CC14**  
FBDPM 3/4 X 3-1/4  
16'



**PT3**  
FBDPM 1 X 3-1/4  
8' | 12' | 16'



**G 412**  
FBDPM 19/32 X 3-1/2  
16'



**535**  
FBDPM 11/16 X 3-1/2  
16'



**L 361C**  
PINE 11/16 X 3-1/2  
16'  
FJPC 11/16 X 3-1/2  
16'



**374**  
FJPC 11/16 X 3-1/2  
16'  
FBDPM 11/16 X 3-1/2  
16'  
OAK 3/4 X 3-1/2  
RL



**446**  
FBDPM 11/16 X 3-1/2  
16'



**P 450**  
FJPM 11/16 X 3-1/2  
7'4" | 10'  
FJPC 11/16 X 3-1/2  
16'



**412 E2E**  
FBDPM 19/32 X 3-1/2  
16'



**444**  
FJPM 11/16 X 3-1/2  
8' | 16'



**444A**  
FBDPM 11/16 X 3-1/2  
16'



**L 361**  
FJPM 11/16 X 3-1/2  
7'4" | 11'



**8954**  
FBDPM 11/16 X 3-1/2  
16'

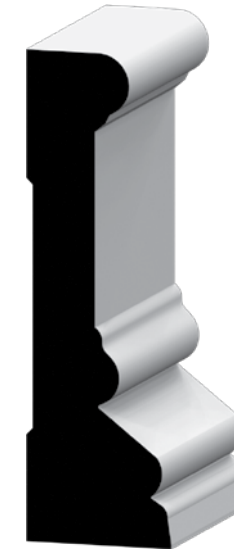

**RB3**  
FBDPM 1 X 3-1/2  
16'

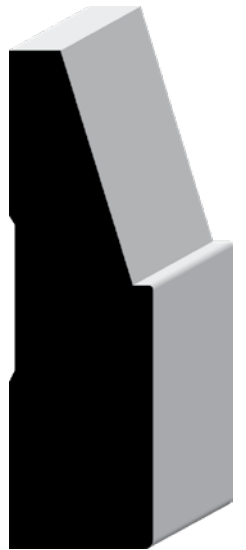

**SC312**  
FBDPM 1 X 3-1/2  
16'

**E412 E2E**  
FJPM 11/16 X 3-1/2  
8' | 16'

**432 E2E**  
FJPM 9/16 X 3-1/2  
16'

# Architraves



Pictured: **SL16** Shiplap | **5030** Architrave | **E412 E2E** Casing

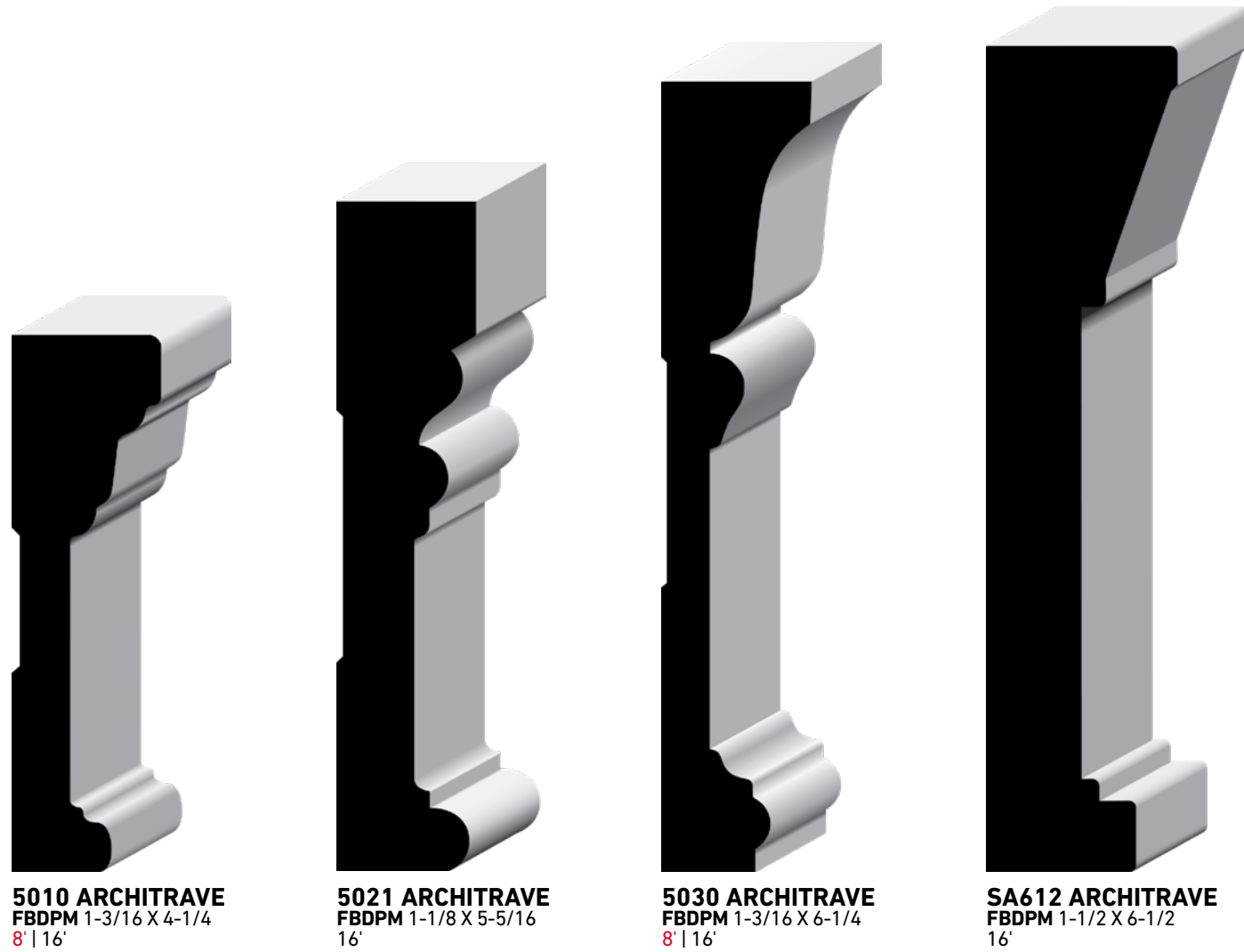

**5010 ARCHITRAVE**  
FBDPM 1-3/16 X 4-1/4  
8' | 16'

**5021 ARCHITRAVE**  
FBDPM 1-1/8 X 5-5/16  
16'

**5030 ARCHITRAVE**  
FBDPM 1-3/16 X 6-1/4  
8' | 16'

**SA612 ARCHITRAVE**  
FBDPM 1-1/2 X 6-1/2  
16'

# Brick | Stool | Back Band

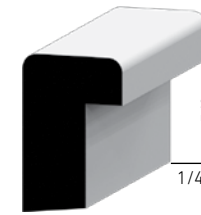

**280 BACK BAND**  
PINE 11/16 X 1-1/16  
8'  
Fits up to 11/16 Profile

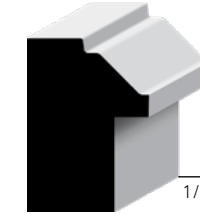

**BVBB BACK BAND**  
FJPM 1-1/16 X 1-1/2  
16'

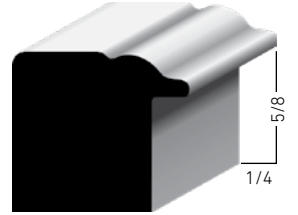

**279 BACK BAND**  
FJPM 1-1/16 X 1-1/8  
16'



**180 BRICK MOULD**  
FJPM 1-1/4 X 2  
8' | 10' | 17'



**L 197 DRIP CAP**  
PINE 5/8 X 1-5/8  
RL

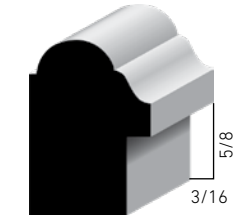

**227 BACK BAND**  
FJPM 1-1/16 X 1-17/32  
16'

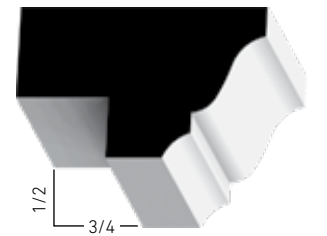

**H 282 BACK BAND**  
POPLAR 2 X 1-1/4  
RL



**4 1021**  
FJPM 11/16 X 4-1/2  
16'



**1153 STOOL**  
PINE 11/16 X 3-1/4  
RL



**1021 STOOL**  
PINE 11/16 X 5-1/4  
RL  
FBDPM 11/16 X 5-1/4  
16'  
FJPM 11/16 X 5-1/4  
16'



**7 1021 STOOL**  
FJPM 11/16 X 7-1/4  
16'



**E 1035 EXTENDED  
HALF ROUND**  
FBDPM 1/2 X 1-3/8  
8'  
POPLAR 1/2 X 1-3/8  
8' | RL

# Stops | Mullions

**857**  
PINE 3/8 X 1-1/4  
7' IRL

**L 887 E2E**  
PINE 3/8 X 1-1/4  
7' IRL  
OAK 3/8 X 1-1/4  
7' IRL  
POPLAR 3/8 X 1-1/4  
7' IRL  
FBDPM 3/8 X 1-1/4  
7' | 16'

**947**  
PINE 3/8 X 1-1/4  
7' | 10' IRL  
OAK 3/8 X 1-1/4  
7'  
POPLAR 3/8 X 1-1/4  
RL  
FJPM 3/8 X 1-1/4  
7' | 11'  
DOUBLE FJPM 3/8 X 1-1/4  
7'

**N 947**  
FBDPM 3/8 X 1-1/4  
7'

**846**  
PINE 7/16 X 1-3/8  
7' IRL

**856**  
PINE 3/8 X 1-3/8  
7' IRL

**876 E1E**  
PINE 7/16 X 1-3/8  
7' | 110"  
POPLAR 7/16 X 1-3/8  
7' IRL  
FJPM 7/16 X 1-3/8  
7' | 82" | 116'

**L 876 E2E**  
FJPM 7/16 X 1-3/8  
7'

**B 876 E2E**  
FBDPM 1/2 (12MM) X 1-3/8  
68" | 69" | 72" | 82"

**936**  
PINE 7/16 X 1-3/8  
7' | RL  
FJPM 7/16 X 1-3/8  
16'  
FJPC 7/16 X 1-3/8  
7'  
OAK 7/16 X 1-3/8  
7' IRL  
POPLAR 7/16 X 1-3/8  
7'

**N 946**  
PINE 3/8 X 1-3/8  
7'  
FBDPM 3/8 X 1-3/8  
7'

**935**  
PINE 7/16 X 1-5/8  
RL

**1305 T-ASTRAGAL**  
PINE 1-1/4 X 2  
7' | 8"  
FJPM 1-1/4 X 2  
8'

**845**  
PINE 7/16 X 1-5/8  
RL

**L 973**  
PINE 3/8 X 1-5/8  
8'

**L 983**  
PINE 3/8 X 1-5/8  
8'

**972 E2E**  
PINE 3/8 X 2  
RL

**982**  
PINE 3/8 X 2  
RL

**L 473 E2E**  
FJPM 7/16 X 2-1/4  
16'

# Base Caps | Base

**L 167 BASE CAP**  
PINE 5/8 X 1-1/8  
8'

**166 BASE CAP**  
PINE 11/16 X 1-1/4  
RL  
FJPM 11/16 X 1-1/4  
16'

**163 BASE CAP**  
FBDPM 11/16 X 1-3/8  
16'  
POPLAR 11/16 X 1-3/8  
RL  
FJPM 11/16 X 1-3/8  
16'

**L 634**  
PINE 7/16 X 3  
8' | 12' IRL  
FJPM 7/16 X 3  
8' | 12' | 16'  
FJPC 7/16 X 3  
16'  
OAK 3/8 X 2-3/4  
8' | 12' IRL

**L 724**  
PINE 7/16 X 3  
8' | 12' | 16'  
FJPM 7/16 X 3  
8' | 12' | 16'  
OAK 3/8 X 2-3/4  
8' | 12'

**714**  
PINE 9/16 X 3  
RL

**H 634**  
POPLAR 1/2 X 3  
RL

**L 635**  
OAK 3/8 X 3  
2L

**L 433 E2E**  
PINE 7/16 X 3-1/4  
RL  
OAK 3/8 X 3  
RL  
POPLAR 3/8 X 3  
RL  
FBDPM 1/2 X 3-1/4  
16'

**433E E1E**  
FJPM 9/16 X 3-1/4  
16'

**L 433E E1E**  
FBDPM 1/2 X 3-1/4  
8' | 12' | 16'  
FJPM 9/16 X 3-1/4  
8' | 12'  
FJPC 9/16 X 3-1/4  
16'

**623**  
PINE 9/16 X 3-1/4  
8' | 12' | 16' RL  
FJPM 9/16 X 3-1/4  
8' | 12' | 16'  
FJPC 9/16 X 3-1/4  
16'  
FBDPM 1/2 X 3-1/4  
8' | 12' | 16'

**L 633**  
PINE 7/16 X 3-1/4  
RL  
FJPC 7/16 X 3-1/4  
16'

**H 633**  
OAK 1/2 X 3-1/4  
RL  
POPLAR 1/2 X 3-1/4  
RL



**663**  
PINE 9/16 X 3-1/4  
RL  
FJPM D 9/16 X 3-1/4  
8' | 12'  
FJPCC 9/16 X 3-1/4  
16'



**P 805**  
FJPM D 9/16 X 3-1/4  
8' | 12'  
FJPCC 9/16 X 3-1/4  
16'



**713**  
PINE 9/16 X 3-1/4  
8' | 12' | 16'  
FJPM D 9/16 X 3-1/4  
8' | 12' | 16'  
FBDPM 1/2 X 3-1/4  
8'



**723**  
OAK 1/2 X 3-1/4  
8'  
**L 723**  
PINE 7/16 X 3-1/4  
RL



**P 808**  
PINE 9/16 X 4-1/4  
RL  
FJPM D 9/16 X 4-1/4  
8' | 12'  
FJPCC 9/16 X 4-1/4  
16'  
FBDPM 1/2 X 4-1/4  
16'  
OAK 1/2 X 4-1/4  
RL  
POPLAR 1/2 X 4-1/4  
RL



**410**  
FBDPM 19/32 X 4-1/4  
16'



**620**  
PINE 9/16 X 4-1/4  
8' | 12' | 16' | RL  
FJPM D 9/16 X 4-1/4  
8' | 12' | 16'  
FJPCC 9/16 X 4-1/4  
16'  
FBDPM 1/2 X 4-1/4  
8' | 12' | 16'



**L 620**  
OAK 1/2 X 4-1/4  
2L  
POPLAR 1/2 X 4-1/4  
RL



**L 414 E1E**  
FJPM D 9/16 X 4-1/4  
8' | 12' | 16'



**414E E1E**  
FBDPM 1/2 X 4-1/4  
16'



**L 430 E1E**  
FJPCC 7/16 X 4-1/4  
16'



**435 E1E**  
OAK 7/16 X 4-1/4  
RL  
POPLAR 7/16 X 4-1/4  
RL



**545**  
FBDPM 19/32 X 5  
16'



**B514**  
FJPM D 11/16 X 5-1/4  
16'

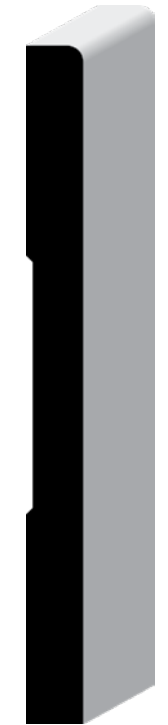

**L 431 E1E**  
FJPCC 7/16 X 5-1/4  
16'



**L 514 E1E**  
POPLAR 7/16 X 5-1/4  
RL  
FJPM D 9/16 X 5-1/4  
8' | 12' | 16'



**G 514**  
FBDPM 1/2 X 5-1/4  
8' | 12' | 16'





**163E**  
FBDPM 19/32 X 5-1/4  
16'

**L 163E**  
FBDPM 1/2 X 5-1/4  
8' | 12'  
FJPM 9/16 X 5-1/4  
8' | 12' | 16'



**B 312**  
FBDPM 19/32 X 5-1/4  
16'



**L 618**  
FBDPM 1/2 X 5-1/4  
16'

**618**  
PINE 9/16 X 5-1/4  
RL  
FJPCC 9/16 X 5-1/4  
16'



**7055**  
FBDPM 19/32 X 5-1/4  
16'

**8740 BASE CAP**  
FJPM 5/8 X 1-3/4  
16'



**512 E2E**  
FBDPM 1/2 X 5-1/2  
8' | 12' | 16'



**L 512 E2E**  
FBDPM 19/32 X 5-1/2  
16'



**L 512E E1E**  
FBDPM 19/32 X 5-1/2  
16'



**512E E1E**  
FBDPM 1/2 X 5-1/2  
16'

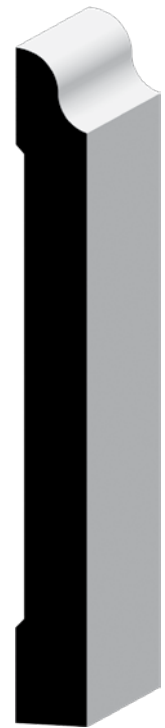

**658**  
FJPCC 9/16 X 5-1/4  
16'



**674**  
FJPCC 9/16 X 5-1/4  
16'  
OAK 1/2 X 5-1/4  
RL



**P 813**  
PINE 9/16 X 5-1/4  
RL  
FJPM 9/16 X 5-1/4  
8' | 12'  
FJPCC 9/16 X 5-1/4  
16'  
FBDPM 1/2 X 5-1/4  
16'  
POPLAR 1/2 X 5-1/4  
RL

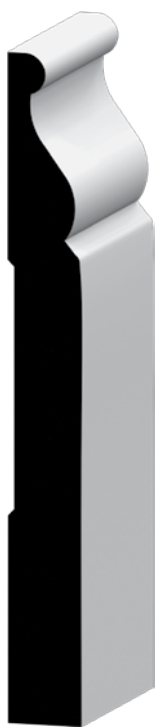

**L P813**  
FBDPM 19/32 X 5-1/4  
16'



**8741**  
FJPM 9/16 X 5-1/4  
16'



**S B512**  
FBDPM 3/4 X 5-1/2  
16'



**8955**  
FBDPM 19/32 X 5-9/16  
16'



**8263**  
FBDPM 19/32 X 6-1/2  
16'



**L P815**  
FBDPM 19/32 X 7-1/4  
16'

**P 815**  
FJPM 9/16 X 7-1/4  
16'

# Base



**B714**  
FJPM 11/16 X 7-1/4  
16'



**7163**  
FBDPM 19/32 X 7-1/4  
16'  
**L 7163 (14mm)**  
FBDPM 9/16 X 7-1/4  
8' | 12'



**E 714 E2E**  
FBDPM 1/2 X 7-1/4  
16'



**714E E1E**  
FBDPM 1/2 X 7-1/4  
16'



**207**  
FBDPM 19/32 X 7-1/4  
16'



5/16  
**2464**  
FJPM 3/4 X 2  
16'



**391**  
PINE 11/16 X 2-1/4  
RL



**390**  
PINE 11/16 X 2-5/8  
8' | RL  
FJPM 11/16 X 2-5/8  
8'  
FJPC 11/16 X 2-5/8  
16'  
FBDPM 19/32 X 2-5/8  
16'  
OAK 5/8 X 2-5/8  
8' | RL  
POPLAR 5/8 X 2-5/8  
RL  
**L 390**  
FBDPM 9/16 X 2-5/8  
8' | 12'



**L 300**  
FBDPM 1 X 2-7/8  
8'



**171 SHELF EDGE**  
POPLAR 9/16 X 3/4  
8'



**427 (A9)**  
PANEL MOULD  
FJPM 9/16 X 1-1/8  
16'



**260 SHELF EDGE**  
OAK 11/16 X 1-1/4  
8'  
POPLAR 11/16 X 1-1/4  
8'



**185**  
PANEL MOULD  
PINE 9/32 X 1-3/8  
RL



**L 184**  
PANEL MOULD  
FJPM 1/2 X 1-1/2  
16'



**182**  
PANEL MOULD  
FJPM 11/16 X 1-5/8  
16'

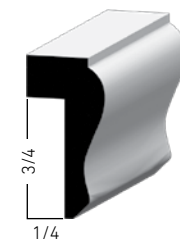

3/4  
1/4  
**292 PLY CAP**  
PINE 9/16 X 1-1/8  
8' | RL



**2448**  
PANEL MOULD  
FJPM 3/4 X 1-1/2  
16'



5/16  
1/2  
**L WCAP**  
WAINSCOTING  
CAP  
FBDPM 11/16 X 2  
8'



1/2  
3/4  
**190 PANEL**  
MOULD  
POPLAR 1 X 2  
RL

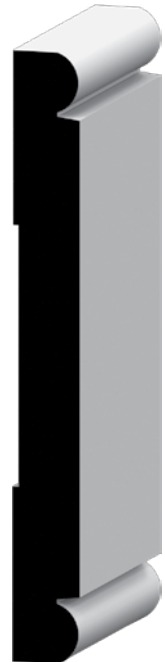

**956W**  
FBDPM 1/2 X 4-1/4  
8'

# Chair Rail | Panel Mould

# Cove | Bed | Crown

# Crown

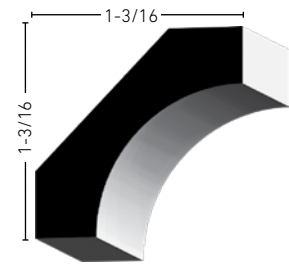

**85**  
PINE 9/16 X 1-3/4  
RL

**86**  
PINE 9/16 X 1-5/8  
8' | 12'

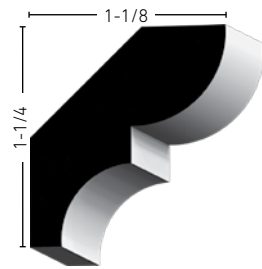

**75**  
PINE 9/16 X 1-5/8  
8' | 12' | RL

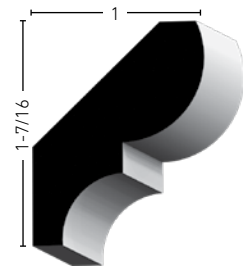

**74**  
PINE 9/16 X 1-3/4  
RL  
FJPM D 9/16 X 1-3/4  
16'

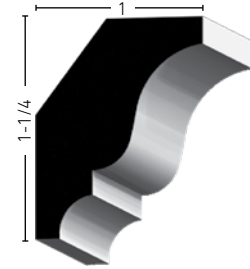

**68**  
PINE 9/16 X 1-5/8  
RL

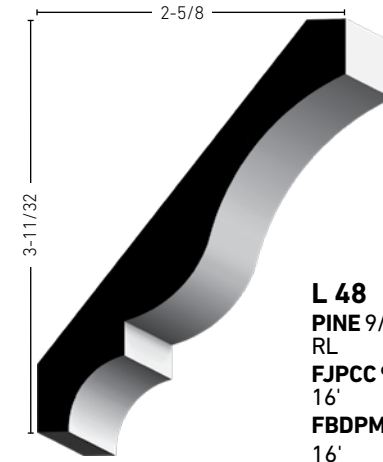

**L 48**  
PINE 9/16 X 4-1/4  
RL  
FJPCC 9/16 X 4-1/4  
16'  
FBDPM 19/32 x 4-1/4  
16'

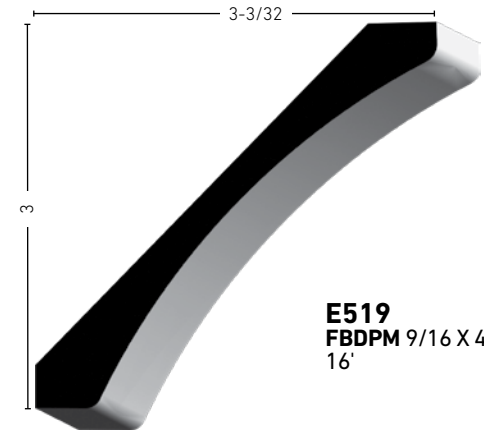

**E519**  
FBDPM 9/16 X 4-1/4  
16'

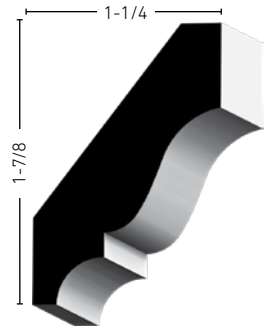

**54**  
PINE 9/16 X 2-1/4  
8' | RL  
FJPM D 9/16 X 2-1/4  
16'

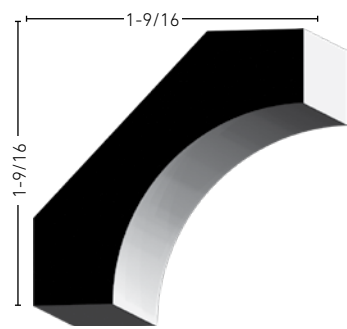

**84**  
PINE 9/16 X 2-1/4  
RL

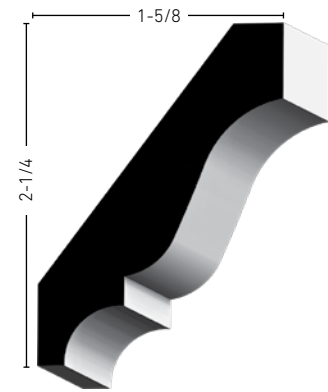

**52**  
PINE 9/16 X 2-3/4  
8' | 12' | RL

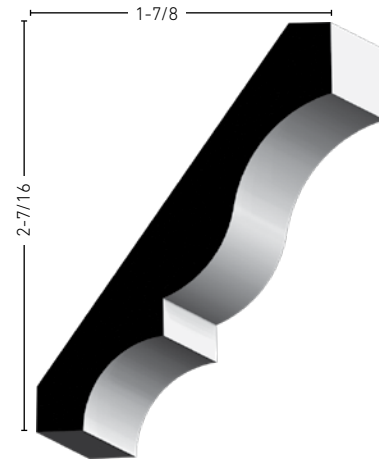

**51**  
OAK 1/2 X 3-1/4  
RL

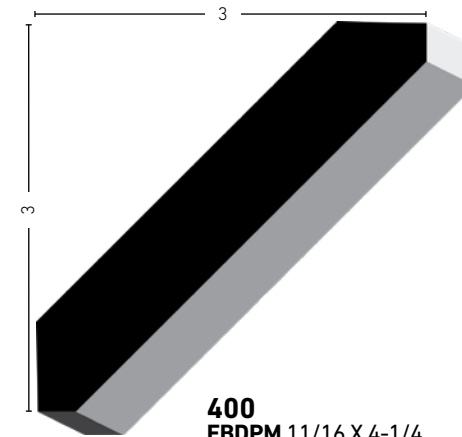

**400**  
FBDPM 11/16 X 4-1/4  
8' | 12'

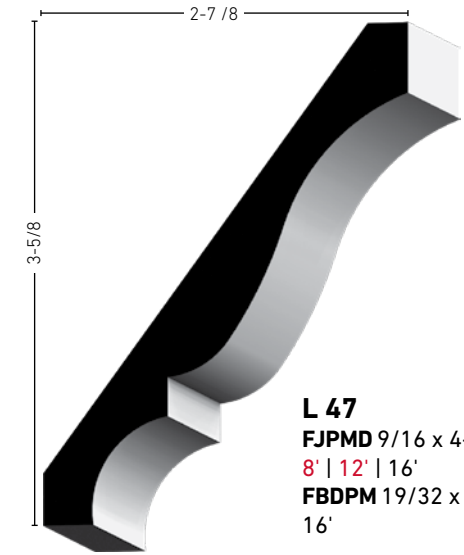

**L 47**  
FJPM D 9/16 x 4-5/8  
8' | 12' | 16'  
FBDPM 19/32 x 4-5/8  
16'

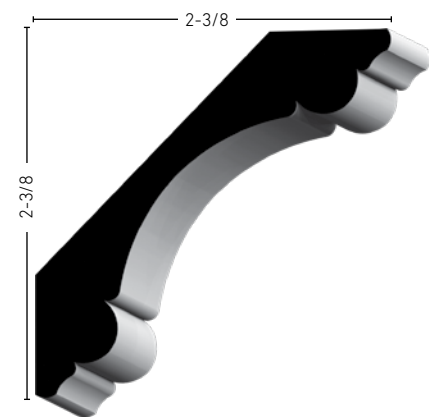

**L 340**  
FBDPM 11/16 X 3-3/8  
8' | 12' | 16'

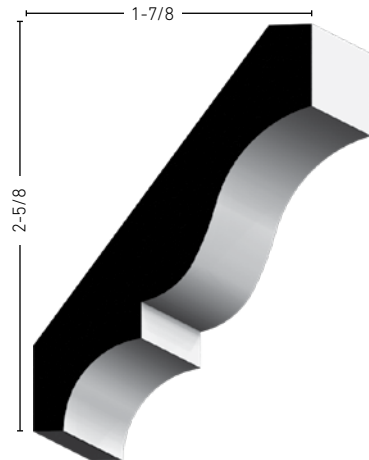

**L 51**  
PINE 9/16 X 3-1/4  
12' | RL  
FJPM D 9/16 X 3-1/4  
8' | 10' | 12' | 16'  
FJPCC 9/16 X 3-1/4  
16'  
POPLAR 9/16 X 3-1/4  
RL

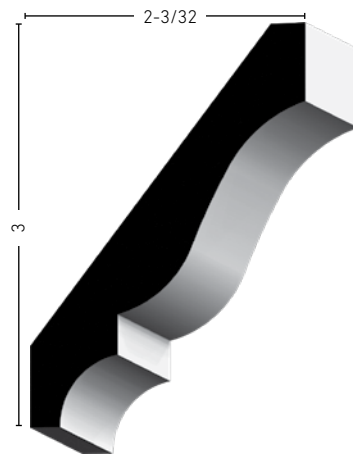

**L 49**  
PINE 9/16 X 3-5/8  
RL  
FJPM D 9/16 X 3-5/8  
8' | 12'  
FJPCC 9/16 X 3-5/8  
16'  
PINE 9/16 X 3-5/8  
8' | 12' | 16'  
FBDPM 19/32 X 3-5/8  
16'

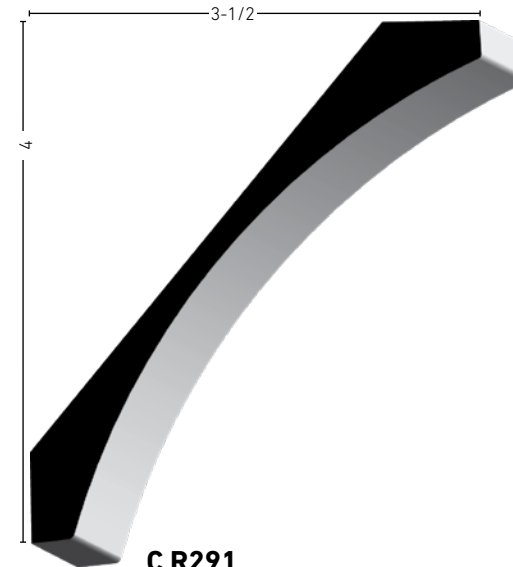

**C R291**  
FBDPM 3/4 X 5-1/4  
16'

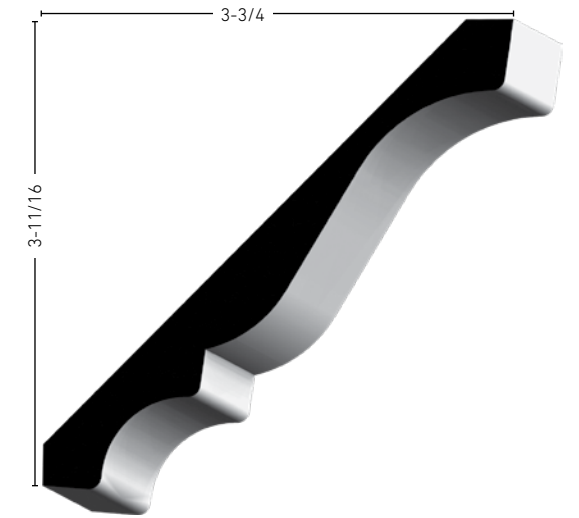

**L 45**  
FBDPM 19/32 X 5-1/4  
16'

**Crown**

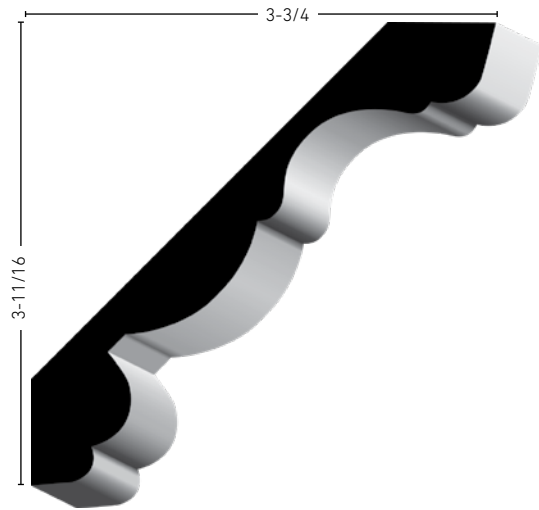

**247**  
FBDPM 7/8 X 5-1/4  
16'

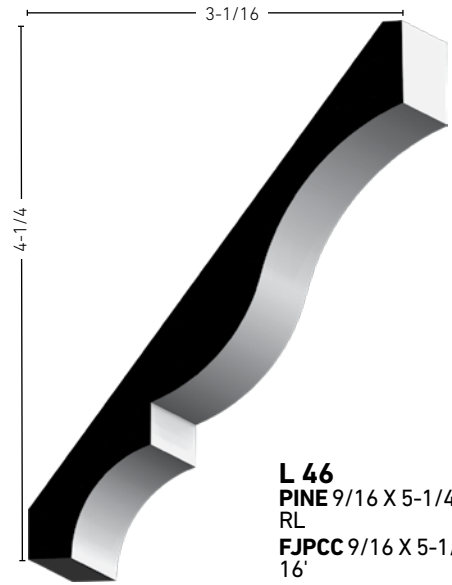

**L 46**  
PINE 9/16 X 5-1/4  
RL  
FJPCC 9/16 X 5-1/4  
16'  
POPLAR 9/16 X 5-1/4  
RL

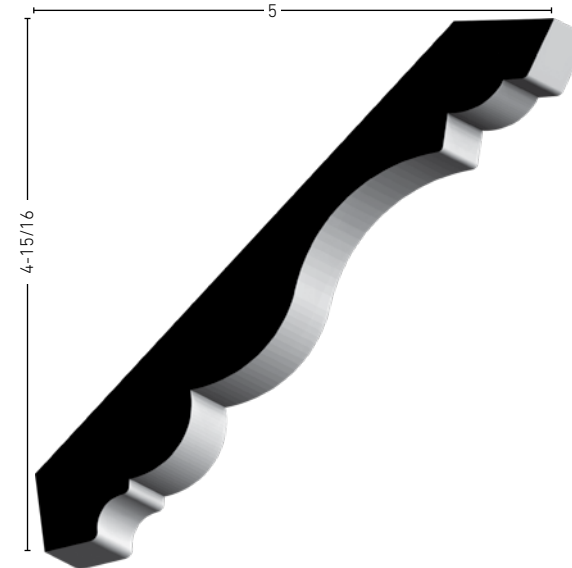

**CR75**  
FBDPM 13/16 X 6-15/16  
16'

**Crown**

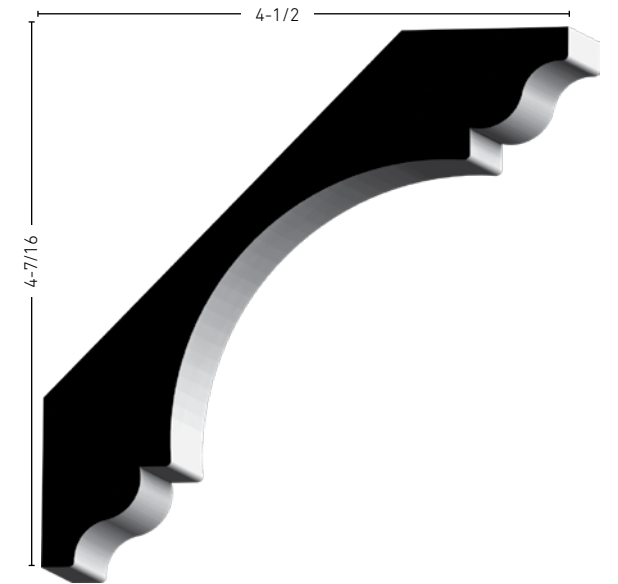

**041**  
FBDPM 1-3/16 X 6-5/16  
16'

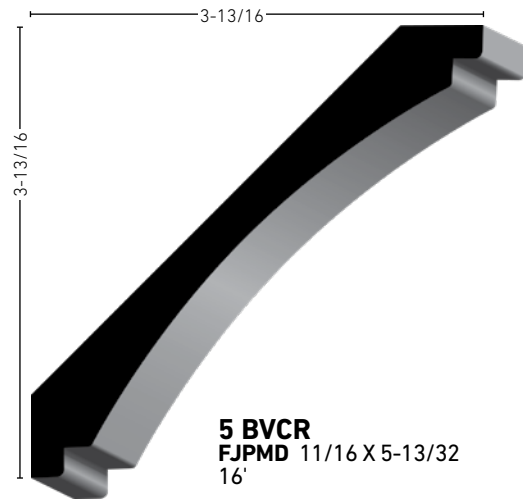

**5 BVCR**  
FJPM 11/16 X 5-13/32  
16'

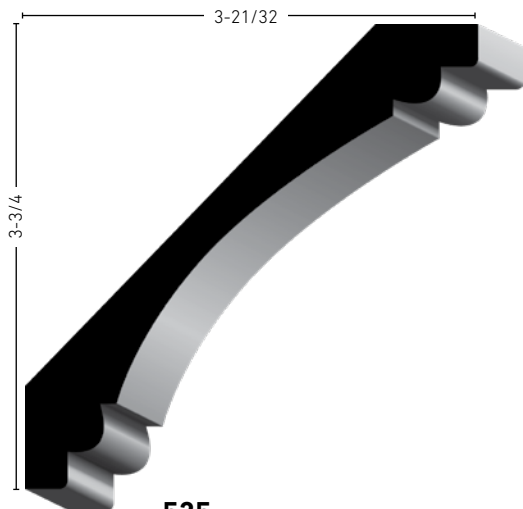

**525**  
FBDPM 11/16 X 5-1/4  
16'

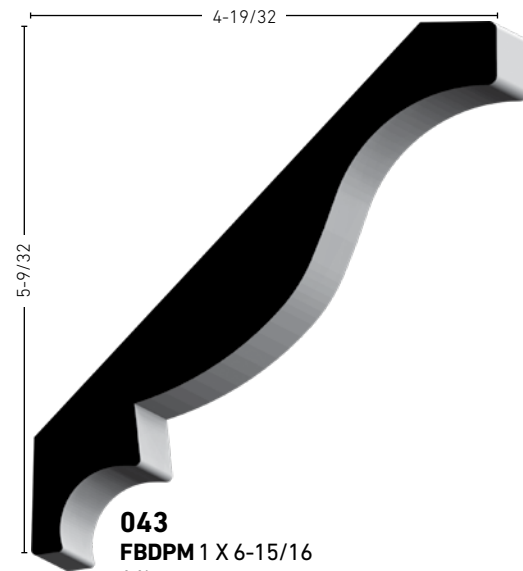

**043**  
FBDPM 1 X 6-15/16  
16'

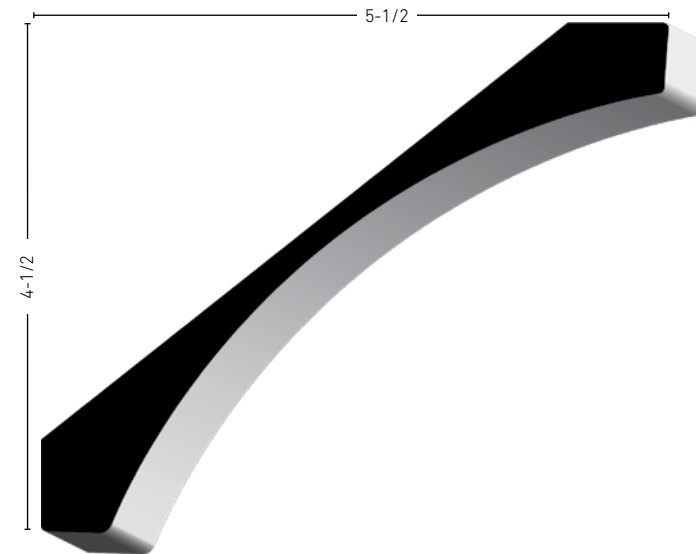

**505**  
FBDPM 1 X 7  
16'

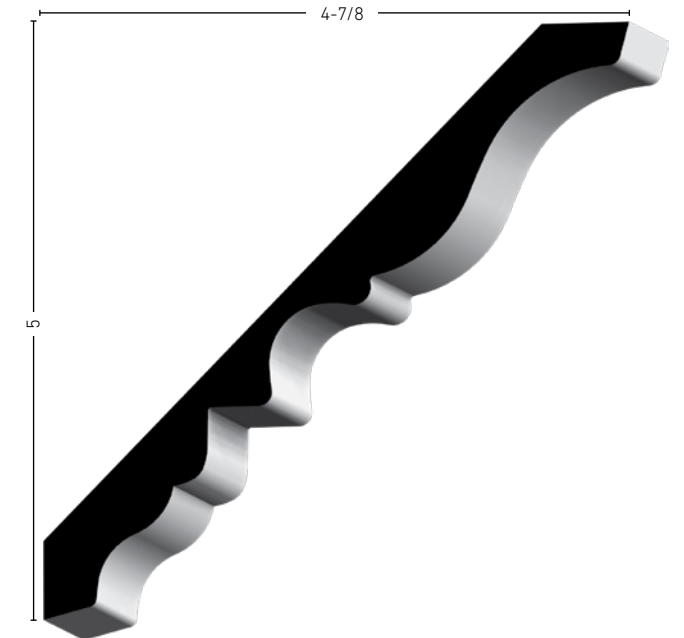

**42**  
FBDPM 11/16 X 7  
16'

## Base Blocks



**PLINTH BLOCK - BEVELED**  
**1401 PB**  
**ORPMD** 7/8 X 2-3/4 X 4-1/2  
**1403 PB**  
**ORPMD** 7/8 x 3-3/4 x 6  
**917 PB**  
**PINES** 1-1/8 x 3-1/2 x 6-1/2  
**OROAK** 1-1/8 x 3-1/2 x 6-1/2



**PLINTH BLOCK - MOULDED**  
**742 PB**  
**PINES** 1-1/8 x 3-1/2 x 6-1/2  
**OROAK** 1-1/8 x 3-1/2 x 6-1/2  
**334 PB**  
**FBDPM** 1 x 3-3/4 x 9  
**438 PB**  
**FBDPM** 1 x 4-3/8 x 9



**BASE BLOCK - OUTSIDE CORNER**  
**8920**  
**OAKSL** 1-1/8 x 6-3/4  
**9 OS**  
**FBDPM** 1-1/4 x 9

**BASE BLOCK - INSIDE CORNER**  
**8951**  
**PINES** 7/8 x 6-3/4  
**OROAK** 7/8 x 6-3/4  
**9 IS**  
**FBDPM** 7/8 x 9



**BASE BLOCK - OUTSIDE CORNER**  
**1892**  
**ORPMD** 1-1/8 x 6-1/2

**BASE BLOCK - INSIDE CORNER**  
**1895**  
**ORPMD** 1-1/8 x 6-1/2



**RADIUS BASE BLOCK**  
**P 808**  
**POPLAR** 9/16 x 4-1/4 x 3/4 RAD  
**P 813**  
**POPLAR** 9/16 x 5-1/4 x 3/4 RAD

## Crown Blocks

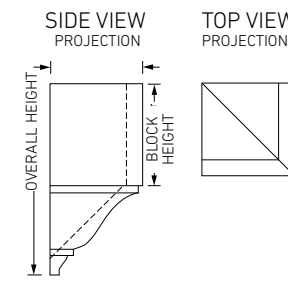

**INSIDE CORNER**  
**1888 - MEDIUM** Block Height - 3  
**ORPIN** 5-5/8 OA-height x 2-5/8 proj.  
**ORPMD** 5-5/8 OA-height x 2-5/8 proj.

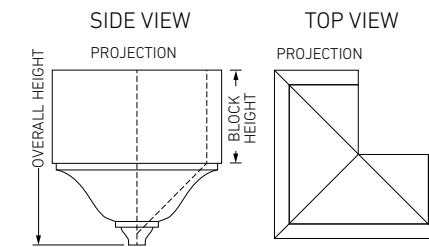

**OUTSIDE CORNER**  
**1888 - MEDIUM** Block Height - 3  
**ORPIN** 5-5/8 OA-height x 2-5/8 proj.  
**ORPMD** 5-5/8 OA-height x 2-5/8 proj.

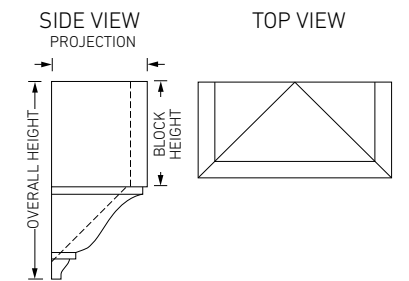

**MIDDLE**  
**1888 - MEDIUM** Block Height - 3  
**ORPMD** 5-5/8 OA-height x 2-5/8 proj.



**OUTSIDE CORNER**  
**1889 - LARGE** Block Height - 4  
**ORPIN** 7-1/2 AO - height x 3-1/2 proj.



**INSIDE CORNER**  
**1889 - LARGE** Block Height - 4  
**ORPIN** 7-1/2 AO - height x 3-1/2 proj.

## Casing Blocks



**BULLSEYE ROSETTE - BEVELED**  
**3**  
**FBDPM** 7/8 x 3  
**334**  
**FBDPM** 7/8 x 3-3/4  
**438**  
**FBDPM** 1 x 4-3/8



**BULLSEYE ROSETTE**  
**642**  
**PINES** 5/8 x 2-1/2  
**OAKSL** 5/8 x 2-1/2  
**B734**  
**OAKSL** 13/16 x 3-1/2



**BULLSEYE ROSETTE - BEVELED**  
**P 358 35**  
**POPLAR** 1 x 3-5/8



**BULLSEYE ROSETTE - BEVELED**  
**1400**  
**ORPMD** 7/8 X 2-3/4  
**1402**  
**ORPMD** 7/8 X 3-3/4

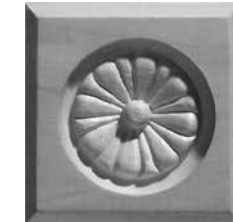

**FLORAL ROSETTE - BEVELED**  
**871**  
**PINES** 1-1/16 X 3-1/2  
**OAKSL** 1-1/16 X 3-1/2  
**915**  
**PINES** 27/32 X 2-1/2  
**OAKSL** 27/32 X 2-1/2

# General Purpose

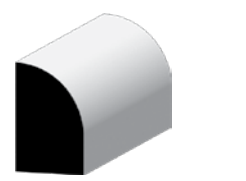

**126 SHOE**  
 PINE 1/2 X 3/4  
 8' | 10' | RL  
 FJPM 1/2 X 3/4  
 12' | 16'  
 OAK 1/2 X 3/4  
 8' | 10' | RL  
 POPLAR 1/2 X 3/4  
 8' | RL  
 POPFP 1/2 X 3/4  
 16'  
 MAPLE 1/2 X 3/4  
 RL  
**129**  
 PINE 7/16 X 11/16  
 8' | 12'  
 FJPM 7/16 X 11/16  
 8' | 12'

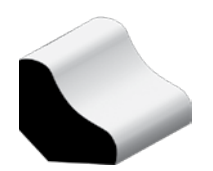

**34 CLOVER LEAF SHOE**  
 PINE 3/4 X 3/4  
 RL  
 OAK 3/4 X 3/4  
 RL

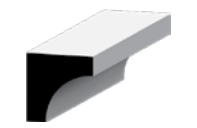

**93 COVE**  
 PINE 3/4 X 3/4  
 8' | RL  
 FJPM 3/4 X 3/4  
 16'  
 OAK 3/4 X 3/4  
 8' | RL  
**100**  
 PINE 11/16 X 11/16  
 8' | 10' | RL  
 FJPM 11/16 X 11/16  
 8'  
 POPLAR 11/16 X 11/16  
 RL



**L 94 COVE**  
 PINE 5/8 X 1-1/8  
 RL



**L 263 LATTICE**  
 PINE 1/4 X 2-1/4  
 8'  
**L 265**  
 PINE 1/4 X 1-3/4  
 8' | RL  
**L 266**  
 PINE 1/4 X 1-1/2  
 8' | 10'  
 FJPM 1/4 X 1-1/2  
 8'  
**L 267**  
 PINE 1/4 X 1-3/8  
 8' | RL  
**L 268**  
 PINE 1/4 X 1-1/8  
 8' | RL

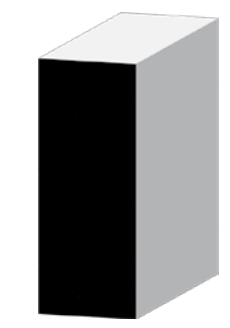

**L 246 SCREEN STOCK**  
 PINE 11/16 X 2-3/4  
 RL  
 FJPM 11/16 X 2-3/4  
 16'  
**246**  
 OAK 3/4 X 2-3/4  
 8'  
 POPLAR RL  
**L 248**  
 PINE 11/16 X 1-3/4  
 8' | RL  
 FJPM 11/16 X 1-3/4  
 16'  
**248**  
 OAK 3/4 X 1-3/4  
 8' | RL  
 POPLAR 3/4 X 1-3/4  
 8' | RL

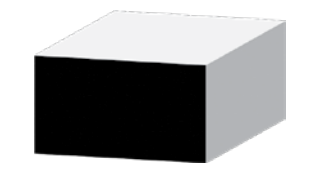

**L 252 BLIND STOP**  
 PINE 11/16 X 1-1/4  
 RL

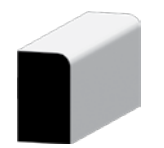

**L 254 CRAFTSMAN SHOE**  
 FJPM 7/16 X 3/4  
 8' | 12' | 16'  
 POPLAR 7/16 X 3/4  
 2L (12' & LONGER)

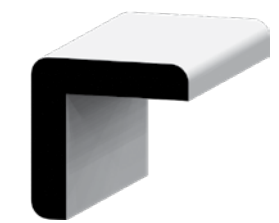

**204 CORNER GUARD**  
 PINE 1-5/16 X 1-5/16  
 8' | RL



**147 GLASS BEAD**  
 PINE 1/2 X 9/16  
 8' | RL



**205**  
 PINE 1-1/8 X 1-1/8  
 8' | RL  
 FJPM 1-1/8 X 1-1/8  
 8'  
 OAK 1-1/16 X 1-1/16  
 8'



**103 QUARTER ROUND**  
 PINE 1-1/16 X 1-1/16  
 RL

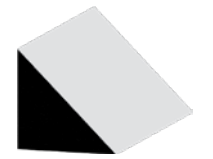

**995 CHAMFER**  
 PINE 3/4 X 3/4  
 RL



**137 SCREEN MOULD-CLOVER**  
 PINE 3/8 X 3/4  
 8'



**206**  
 PINE 3/4 X 3/4  
 8' | RL  
 OAK 3/4 X 3/4  
 8'

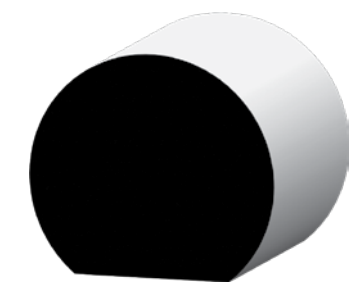

**231 HAND RAIL**  
 DFIR 1-1/2 X 1-11/16  
 8' | 12' | 14' | 16'  
 SPINE 1-1/2 X 1-11/16  
 8' | 12' | 16'  
 POPLAR 1-1/2 X 1-11/16  
 14' | 16'

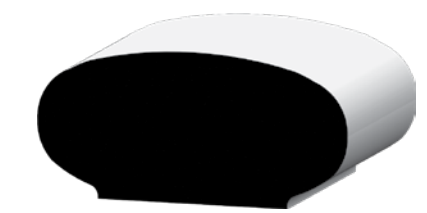

**240 HAND RAIL**  
 DFIR 1-1/4 X 2-1/4  
 16' | RL  
 SPINE 1-1/4 X 2-1/4  
 8' | 12' | 16'

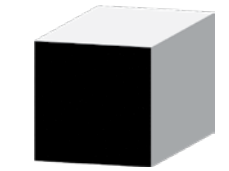

**238 SQUARE**  
 PINE 1-1/16 X 1-1/16  
 8'

**105**  
 PINE 3/4 X 3/4  
 8' | 10' | 12' | RL  
 OAK 3/4 X 3/4  
 8' | RL  
 FJPM 3/4 X 3/4  
 16'  
 POPLAR 3/4 X 3/4  
 RL



**123 HALF ROUND**  
 PINE 5/16 X 5/8  
 8' | RL



**144 SCREEN MOULD-BEADED**  
 PINE 1/4 X 3/4  
 8'

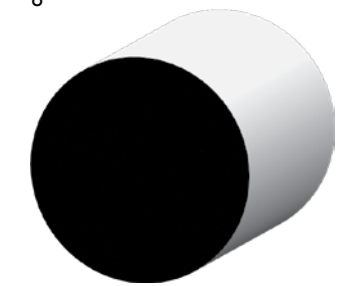

**L 232 CLOSET POLE**  
 DFIR 1-9/16 FULL ROUND  
 8'  
 SPINE 1-9/16 FULL ROUND  
 8'

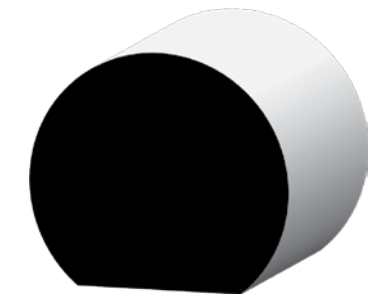

**6040 HAND RAIL**  
 OAK 1-3/4 X 1-5/8  
 8' | 16'  
 POPLAR 1-3/4 X 1-5/8  
 8' | 16' | 18'  
 MAPLE 1-3/4 X 1-5/8  
 16'

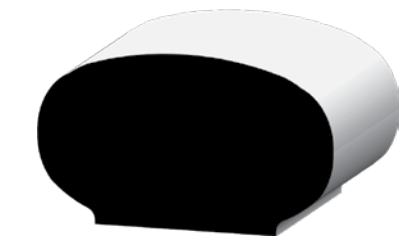

**6042 HAND RAIL**  
 OAK 2-1/4 X 1-9/32  
 14' | 16'  
 POPLAR 2-1/4 X 1-9/32  
 12' | 14' | 16' | 18'  
 MAPLE 2-1/4 X 1-9/32  
 16'



**L 230 HAND RAIL**  
 DFIR 1-1/4 X 2  
 8' | 12' | 16'  
 POPLAR 1-3/32 X 2  
 16'

**106**  
 PINE 11/16 X 11/16  
 8' | 12' | RL  
 FJPM 11/16 X 11/16  
 8' | 12' | 16'



**E 1035 EXTENDED HALF ROUND**  
 FBDPM 1/2 X 1-3/8  
 8'  
 POPLAR 1/2 X 1-3/8  
 8' | RL



**142 SCREEN MOULD**  
 PINE 1/4 X 3/4  
 8' | RL  
 OAK 1/4 X 3/4  
 8'  
 POPLAR  
 RL

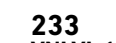



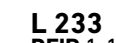





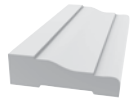

**233**  
 VNLVL 1-15/16 FULL ROUND  
 VINYL WRAPPED WOOD  
 6' | 8'







**L 233**  
 DFIR 1-1/4 FULL ROUND  
 8' | 10' | 12' | RL  
 SPINE 1-1/4 FULL ROUND  
 8' | 16'  
 LVLBA 1-1/4 FULL ROUND  
 LAMINATED VENEER LUMBER  
 16'

EMPIRE SKU	LENGTH	SPECIE	DESCRIPTION
4916 68 FJPM	6'8"	Finger Joint Primed Pine	11/16 X 4-9/16 JAMB PAIR 81BD
2 4916 68 SPTFP	6'8"	Finger Joint Primed Pine	4-9/16 X 2-3/4 X 2-1/2 SPLIT JAMB PAIR
4916 70 FJPM	7'	Finger Joint Primed Pine	11/16 X 4-9/16 JAMB PAIR 85BD
4916 80 FJPM	8'	Finger Joint Primed Pine	11/16 X 4-9/16 JAMB PAIR 97BD
4916 R7 FJPM	17'	Finger Joint Primed Pine	11/16 X 4-9/16 JAMB LINEAL
458 68 FJPM	6'8"	Finger Joint Primed Pine	11/16 X 4-5/8 JAMB PAIR 81BD
458 80 FJPM	8'	Finger Joint Primed Pine	11/16 X 4-5/8 JAMB PAIR 97BD
478 68 FJPM	6'8"	Finger Joint Primed Pine	11/16 X 4-7/8 FLAT JAMB PAIR 81BD
478 80 FJPM	8'	Finger Joint Primed Pine	11/16 X 4-7/8 FLAT JAMB PAIR 97BD
5 80 FJPM	8'	Finger Joint Primed Pine	11/16 X 5 JAMB PAIR 97BD
514 68 FJPM	6'8"	Finger Joint Primed Pine	11/16 X 5-1/4 FLAT JAMB PAIR 81BD
678 68 FJPM	6'8"	Finger Joint Primed Pine	11/16 X 6-7/8 FLAT JAMB PAIR 81BD
678 80 FJPM	8'	Finger Joint Primed Pine	11/16 X 6-7/8 FLAT JAMB PAIR 97BD
6916 68 FJPM	6'8"	Finger Joint Primed Pine	11/16 X 6-9/16 JAMB PAIR 81BD
6916 70 FJPM	7'	Finger Joint Primed Pine	11/16 X 6-9/16 JAMB PAIR 85BD
6916 80 FJPM	8'	Finger Joint Primed Pine	11/16 X 6-9/16 JAMB PAIR 97BD
714 80 FJPM	8'	Finger Joint Primed Pine	11/16 X 7-1/4 JAMB PAIR 97BD
2 4916 68 SPLTS	6'8"	Pine	4-9/16 X 2-3/4 FM X 2-1/2 M SPLIT JAMB PAIR
4916 68 PINEV	6'8"	Pine Veneer w/FJ Core	11/16 X 4-9/16 JAMB PAIR 81BD
X4916 68 PINEL	6'8"	Pine Veneer w/FJ Core	4-9/16 X 2-3/4 FM X 2-1/2 M SPLIT JAMB PAIR
458 70 PINEV	7'	Pine Veneer w/FJ Core	11/16 X 4-5/8 JAMB PAIR 85BD
478 68 PINEV	6'8"	Pine Veneer w/FJ Core	11/16 X 4-7/8 JAMB PAIR 81BD
514 68 PINEV	6'8"	Pine Veneer w/FJ Core	11/16 X 5-1/4 JAMB PAIR 81BD
6916 68 PINEV	6'8"	Pine Veneer w/FJ Core	11/16 X 6-9/16 JAMB PAIR 81BD
6916 80 PINEV	8'	Pine Veneer w/FJ Core	11/16 X 6-9/16 JAMB PAIR 97BD
V 4916 68 OAKOV	6'8"	Oak Veneer w/FJ Core	11/16 X 4-9/16 JAMB PAIR 81BD
X 4916 68 FBDPM	6'8"	MDF	11/16 X 4-9/16 JAMB SIDE 81BD
X 4916 68 ARMWL	6'8"	Armourwood	11/16 X 4-9/16 EXTERIOR JAMB SIDE 81BD

Window / Door

-  **2355 CASING (356)**  
WHITE 11/16 X 2-1/4  
8' | 12'
-  **2449 DRIP CAP**  
WHITE 11/16 X 1-5/8  
12'
-  **2599 SHINGLE MOULDING**  
WHITE 11/16 X 1-5/8  
8'
-  **7526 BRICK MOULD**  
WHITE 1-1/4 X 2  
8' | 10' | 17'  
(3-0 mitered sets available)
-  **2497 JAMB**  
WHITE 3/4 X 5-7/8  
7' | 10'
-  **2100 THERMO STOP**  
WHITE 7/16 X 1-7/8  
7' | 9' | 16'
-  **2149 THERMO STOP**  
BROWN 7/16 X 2  
9'  
SANDSTONE 7/16 X 2  
9'
-  **2150 STOP**  
WHITE 5/8 X 1-1/2  
12'
-  **2330 BLIND STOP**  
WHITE 5/8 X 5/8  
8'
-  **7788 COLONIAL STOP**  
WHITE 3/8 X 1-1/4  
8'









Floor

-  **2450 BASE CAP**  
WHITE 11/16 X 1-1/8  
8'
-  **7527 BASE**  
WHITE 9/16 X 3-1/4  
8' | 12'
-  **2024 QUARTER ROUND**  
WHITE 1/2 X 1/2  
8'
-  **2689 QUARTER ROUND**  
WHITE 3/4 X 3/4  
8' | 12'
-  **2046 SHOE**  
WHITE 5/16 X 3/4  
8'



Ceiling

-  **2021 COVE**  
WHITE 3/4 X 3/4  
8'
-  **2598 BED MOULD**  
WHITE 9/16 X 1-5/8  
12'
-  **7158 RAMS CROWN**  
WHITE 1-13/32 X 2-1/16  
12'
-  **2435 CROWN**  
WHITE 9/16 X 3-5/8  
12'
-  **7901 SHINGLE PANEL**  
WHITE 21/32 X 1-23/32  
8'
-  **2258 EXTERIOR BEAD**  
WHITE 1/2 X 13/32  
8'

Wall & Trim

-  **N 2878 PANEL**  
WHITE 3/8 X 4  
8'
-  **2352 EXTERIOR PLANKING**  
WHITE 3/8 X 5-15/32  
8'
-  **9825 REVERSIBLE BEADED/V-GROOVE NICKEL GAP PANEL**  
WHITE 5/16 X 7-5/16  
8'
-  **2709 FLAT UTILITY TRIM**  
WHITE 5/16 X 5-3/16  
8' | 12'
-  **7318 (1X4) TRIM PLANK**  
WHITE 3/4 X 3-1/2  
8' | 12'
-  **7311 (1X6) TRIM PLANK**  
WHITE 3/4 X 5-1/2  
8' | 12'
-  **8983 TRIMPLANK**  
WHITE 5/8 X 1-1/2  
8'
-  **9836 CRAFTSMAN CHAIR RAIL / BASE TRIM KIT**  
WHITE 5/8 X 2-1/2  
8'
-  **7719 PVC SMOOTH OS CRNR (WM205)**  
WHITE 1-1/8 X 1-1/8  
8' | 12'

Miscellaneous

-  **2807 RAKE MOULDING**  
WHITE 1X2  
12'
-  **9134 SCREEN MOULD**  
WHITE 1/4 X 3/4  
8'
-  **2018 LATTICE**  
WHITE 1/4 X 1-1/2  
8'

# Moulding Index

Part#	Pg#
3	40
9 IS	40
9 OS	40
34	42
40	23
041	39
42	39
043	38
L 45	37
L 46	38
L 47	37
L 48	37
L 49	36
L 51	36
51	36
52	36
54	36
68	36
74	36
CR75	39
75	36
84	36
85	36
86	36
93	42
L 94	42
100	42
103	42
105	42
106	42
108	42
110	42
123	42
126	42
129	42
137	42
142	42
144	42
147	42
L163E	32
163E	32
163	29
166	29
L 167	29
171	29
180	29
182	29
L 184	35
185	35
190	35
L 197	27
204	42
205	42
206	42
207	34
227	27
L 230	43
231	43
L 232	42
233	42

Part#	Pg#
L 233	42
238	43
239	43
240	43
L 246	43
246	43
247	38
L 248	43
248	43
L 252	43
L 254	42
254	43
260	35
L 263	43
L 265	43
L 266	43
L 267	43
L 268	43
279	27
280	27
H 282	27
C R291	37
292	35
L 300	35
312	22
SC312	25
B 312	32
316	21
321	21
L 324	21
324	21
B325	23
327	21
334	40
334 PB	40
L 340	36
351	22
L 356	21
356	21
P 358 35	40
L 361	24
S 361	22
361	22
L 361C	25
L 366	21, 23
366	21
366A	21
374	25
376	21
P 380	22
L 390	35
390	35
391	35
400	37
410	31
411	23
412	24
E412	24
G 412	24
414E	30

Part#	Pg#
L 414	30
427	35
L 430	30
L 431	31
432	24
L 433	29
L 433E	29
433E	29
L 434	23
435	30
438	40
438 PB	40
L 444	23
444A	24
444	24
445	23
445A	23
446	25
P 450	25
453	22
L 471	22
472	22
L 473 Casing	22
L 473 Stop	28
473	21
474	22
505	39
512	33
512E	33
SB512	33
L 512	33
L 512E	33
B514	31
G 514	31
L 514	31
E519	37
525	38
535	24
545	31
SA612	26
L 618	32
618	32
L 620	31
620	31
623	29
L 633	29
H 633	29
L 634	29
H 634	29
L 635	29
642	40
658	32
663	30
674	32
682	23
683	23
685	22
713	30
B714	34
E714	34

Part#	Pg#
714	29
714E	34
L 723	30
723	30
L 724	29
B 734	40
742 PB	40
P 805	40
P 808	31
P 808 Block	40
L P813	32
P 813	32
P 813 Block	40
L P815	33
P 815	33
845	28
846	28
856	28
857	28
871	41
B 876	28
L 876	28
876	28
L 887	28
915	41
917 PB	40
935	28
936	28
N 946	28
947	28
N947	28
956W	35
972	28
L 973	28
982	28
L 983	28
995	42
4 1021	27
7 1021	27
1021	27
E 1035	27, 42
1153	27
1305	28
1400	41
1401 PB	40
1402	41
1403 PB	40
1888	41
1889	41
1892	40
1895	40
2018	45
2021	45
2024	45
2046	45
2100	45
2149	45
2150	45
2258	45
2330	45

Part#	Pg#
2352	45
2355	45
2435	45
2448	35
2449	45
2450	45
2464	35
2497	45
2598	45
2599	45
2689	45
2709	45
2807	45
N 2878	45
4520	22
5010	26
5021	26
5030	26
6040	43
6042	43
7055	32
7158	45
7163	34
L 7163	34
7311	45
7318	45
7526	45
7527	45
7719	45
7788	45
7901	45
8263	33
8740	32
8741	32
8920	40
8951	40
8954	25
8955	33
8983	45
9134	45
9825	45
9836	45
BVBB	27
5 BVCR	38
L CC14	24
L FLTD	22
PT3	24
RB3	25
L WCAP	35
Boards	14-17
Wainscot/ Shiplap	18-19
Jambs	44

# Quality Products



## Mouldings

- Softwood Mouldings
- Hardwood Mouldings
- Blocks
- Flexible Mouldings



A NOVO Building Products Company



## Boards

- Softwood Boards
- Hardwood Boards
- S4S & Eased Edged
- Unfinished, Primed



A NOVO Building Products Company



## Stair Parts

- Wood Balusters & Newels
- Iron Balusters & Newels
- Post to Post Components
- Over the Post Components
- Stock, Special Order, Custom

## New Cable Styles

- Marine grade 316 stainless steel cable and hardware for interior or exterior use
- Sleek exclusive swageless cable fittings require no special tools for installation
- Newels are precut and predrilled saving hours and hours of installation time
- Hollow tube infill option available
- Solid box treads for a total industrial modern design
- New code compliant handrail profile



## Columns

- Architectural Wood
- Wood Colonial
- Poly-Classic
- Poly-Classic DuraGlass Square
- Poly-Classic Craftsman
- Poly-Classic Porch Posts
- Wood Porch Posts



## Decorative Millwork

- Decorative Wood Mouldings
- Mantels, Wood Beams
- Decorative Risers
- Stained Boards

## ORNAMENTAL

DECORATIVE MILLWORK

A NOVO Building Products Company





Explore our comprehensive collections of mouldings, stair parts, boards, and exterior millwork as well as find inspiration for every room in the home.



## Great Lakes Distribution Center

P.O. Box 17  
8181 Logistic Drive | Zeeland, MI 49464  
**P: 800.253.9000 | F: 800.748.7670**

© 2021 EMPIRE CO. E1(Rev.03/21)

Empire reserves the right to make changes to the products listed in this catalog without notice and without responsibility for existing units. Drawings may not be to exact scale.

Scan to place orders on our  
NEW Empire Pro Dealer Portal  
**PRO.EMPIRECO.COM**

See page 5 for more information.

